

Operating Guide

ECL Comfort 210 / 296 / 310, application A266



1.0 Table of Contents

1.0 Table of Contents	1	6.0 Common controller settings	122
1.1 Important safety and product information.....	2	6.1 Introduction to 'Common controller settings'	122
2.0 Installation	6	6.2 Time & Date	123
2.1 Before you start	6	6.3 Holiday	124
2.2 Identifying the system type.....	14	6.4 Input overview	126
2.3 Mounting	15	6.5 Log	127
2.4 Placing the temperature sensors.....	19	6.6 Output override.....	128
2.5 Electrical connections.....	21	6.7 Key functions	129
2.6 Inserting the ECL Application Key	30	6.8 System.....	131
2.7 Check list	37	7.0 Miscellaneous	138
2.8 Navigation, ECL Application Key A266	38	7.1 ECA 30 / 31 setup procedures	138
3.0 Daily use	58	7.2 Override function	146
3.1 How to navigate	58	7.3 Several controllers in the same system	149
3.2 Understanding the controller display	59	7.4 Frequently asked questions.....	152
3.3 A general overview: What do the symbols mean?	63	7.5 Definitions	155
3.4 Monitoring temperatures and system components	64	7.6 Type (ID 6001), overview	159
3.5 Influence overview	65	7.7 Automatic / manual update of firmware.....	160
3.6 Manual control	66	7.8 Parameter ID overview.....	161
3.7 Schedule	67		
4.0 Settings overview	68		
5.0 Settings	71		
5.1 Introduction to Settings	71		
5.2 Flow temperature.....	72		
5.3 Room limit	75		
5.4 Return limit	77		
5.5 Flow / power limit	83		
5.6 Optimization.....	88		
5.7 Control parameters.....	95		
5.8 Application	102		
5.9 Heat cut-out	110		
5.10 Alarm	113		
5.11 Alarm overview	119		
5.12 Anti-bacteria.....	120		

Operating Guide ECL Comfort 210 / 296 / 310, application A266

1.1 Important safety and product information

1.1.1 Important safety and product information

This Operating Guide is associated with ECL Application Key A266 (order code no. 087H3800).

The ECL Application Key A266 contains 4 subtypes, all applicable in ECL Comfort 210, 296 and 310:

- A266.1: Heating and DHW
- A266.2: Heating and advanced DHW
- A266.9: Heating inclusive pressure monitoring and DHW. Return temperature monitoring on heating side.
- A266.10: Heating and DHW. Return temperature monitoring on heating side.

The A266 application key also contains a Floor (Screed) Drying Program. See separate documentation. (In English and German language only).

See the Installation Guide (delivered with the application key) for application examples and electrical connections.

The described functions are realized in ECL Comfort 210 for basic solutions and in ECL Comfort 296 and 310 for advanced solutions, for example M-bus, Modbus and Ethernet (Internet) communication.

The application Key A266 complies with ECL Comfort 210, ECL Comfort 296 and ECL Comfort 310 controllers as of software version 1.11 (visible at start-up of the controller and in 'Common controller settings' in 'System').

Up to two Remote Control Units, ECA 30 or ECA 31, can be connected and the built-in room temperature sensor can be utilized.

Together with the ECL Comfort 310, the additional Internal I/O module ECA 32 (order code no. 087H3202) can be used for extra data communication to SCADA:

- Temperature, Pt 1000 (default)
- 0 - 10 volt signals

The set-up of input type can be done by means of the Danfoss Software "ECL Tool".

Navigation: Danfoss.com > Service and support > Downloads > Tools > ECL Tool. The URL is:
<https://www.danfoss.com/en/service-and-support/downloads>

The Internal I/O module ECA 32 is placed in the base part for ECL Comfort 310.

ECL Comfort 210 is available as:

- ECL Comfort 210, 230 volt a.c. (087H3020)
- ECL Comfort 210B, 230 volt a.c. (087H3030)

ECL Comfort 296 is available as:

- ECL Comfort 296, 230 volt a.c. (087H3000)

ECL Comfort 310 is available as:

- ECL Comfort 310, 230 volt a.c. (087H3040)
- ECL Comfort 310B, 230 volt a.c. (087H3050)
- ECL Comfort 310, 24 volt a.c. (087H3044)

Operating Guide ECL Comfort 210 / 296 / 310, application A266

The B-types have no display and dial. The B-types are operated by means of the Remote Control unit ECA 30 / 31:

- ECA 30 (087H3200)
- ECA 31 (087H3201)

Base parts for ECL Comfort:

- for ECL Comfort 210, 230 volt a.c. (087H3220)
- for ECL Comfort 296, 230 volt a.c. (087H3240)
- for ECL Comfort 310, 230 volt a.c. and 24 volt a.c (087H3230)

Additional documentation for ECL Comfort 210, 296 and 310, modules and accessories is available on <http://danfoss.com/>.

Documentation for ECL Portal: See <https://ecl.portal.danfoss.com>.



Application keys might be released before all display texts are translated. In this case the text is in English.



Automatic update of controller software (firmware):

The software of the controller is updated automatically when the key is inserted (as of controller version 1.11 (ECL 210 / 310) and version 1.58 (ECL 296)). The following animation will be shown when the software is being updated:

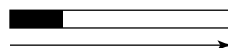

Progress bar

During update:

- Do not remove the KEY
If the key is removed before the hour-glass is shown, you have to start afresh.
- Do not disconnect the power
If the power is interrupted when the hour-glass is shown, the controller will not work.
- Manual update of controller software (firmware):
See the section "Automatic / manual update of firmware"



Safety Note

To avoid injury of persons and damages to the device, it is absolutely necessary to read and observe these instructions carefully.

Necessary assembly, start-up, and maintenance work must be performed by qualified and authorized personnel only.

Local legislations must be respected. This comprises also cable dimensions and type of isolation (double isolated at 230 V).

A fuse for the ECL Comfort installation is max. 10 A typically.

The ambient temperature ranges for ECL Comfort in operation are:

ECL Comfort 210 / 310: 0 - 55 °C

ECL Comfort 296: 0 - 45 °C.

Exceeding the temperature range can result in malfunctions.

Installation must be avoided if there is a risk for condensation (dew).

The warning sign is used to emphasize special conditions that should be taken into consideration.



This symbol indicates that this particular piece of information should be read with special attention.



As this Operating Guide covers several system types, special system settings will be marked with a system type. All system types are shown in the chapter: 'Identifying your system type'.



°C (degrees Celsius) is a measured temperature value whereas K (Kelvin) often is used for temperature differences.



The ID no. is unique for the selected parameter.

Example	First digit	Second digit	Last three digits
11174	1	1	174
	-	Circuit 1	Parameter no.
12174	1	2	174
	-	Circuit 2	Parameter no.

If an ID description is mentioned more than once, it means that there are special settings for one or more system types. It will be marked with the system type in question (e.g. 12174 - A266.9).



Parameters indicated with an ID no. like "1x607" mean a universal parameter.
x stands for circuit / parameter group.



Disposal Note

This symbol on the product indicates that it may not be disposed of as household waste. It must be handed over to the applicable take-back scheme for the recycling of electrical and electronic equipment.

- Dispose of the product through channels provided for this purpose.
- Comply with all local and currently applicable laws and regulations.

Operating Guide ECL Comfort 210 / 296 / 310, application A266

2.0 Installation

2.1 Before you start

The ECL Application key A266 contains 4 subtypes, **A266.1**, **A266.2**, **A266.9** and **A266.10** which are almost identical.

The application **A266.1** is very flexible. These are the basic principles:

Heating (circuit 1):

Typically, the flow temperature is adjusted according to your requirements. The flow temperature sensor (S3) is the most important sensor. The desired flow temperature at S3 is calculated in the ECL controller, based on the outdoor temperature (S1) and the desired room temperature. The lower the outdoor temperature, the higher the desired flow temperature.

By means of a week schedule, the heating circuit can be in 'Comfort' or 'Saving' mode (two values for the desired room temperature). In Saving mode the heating can be reduced or switched off totally.

The motorized control valve (M2) is opened gradually when the flow temperature is lower than the desired flow temperature and vice versa.

The return temperature (S5) can be limited, for example not to be too high. If so, the desired flow temperature at S3 can be adjusted (typically to a lower value), thus resulting in a gradual closing of the motorized control valve. Furthermore, the return temperature limitation can be dependent on the outdoor temperature. Typically, the lower the outdoor temperature, the higher the accepted return temperature.

In boiler-based heating supply the return temperature should not be too low (same adjustment procedure as above).

If the measured room temperature does not equal the desired room temperature, the desired flow temperature can be adjusted.

The circulation pump, P2, is ON at heat demand or at frost protection.

The heating can be switched OFF when the outdoor temperature is higher than a selectable value.

A connected flow or energy meter based on pulses (S7) can limit the flow or energy to a set maximum value. Furthermore the limitation can be in relation to the outdoor temperature. Typically, the lower the outdoor temperature, the higher the accepted flow / power. When the A266.1 is used in an ECL Comfort 310 the flow / energy signal can alternatively come as an M-bus signal.

The frost protection mode maintains a selectable flow temperature, for example 10 °C.

DHW (circuit 2):

If the measured DHW temperature (S4) is lower than the desired DHW temperature, the motorized control valve (M1) is opened gradually and vice versa.

The return temperature (S6) can be limited to a fixed value.

By means of a week schedule, the DHW circuit can be in 'Comfort' or 'Saving' mode (two values for the desired DHW temperature).

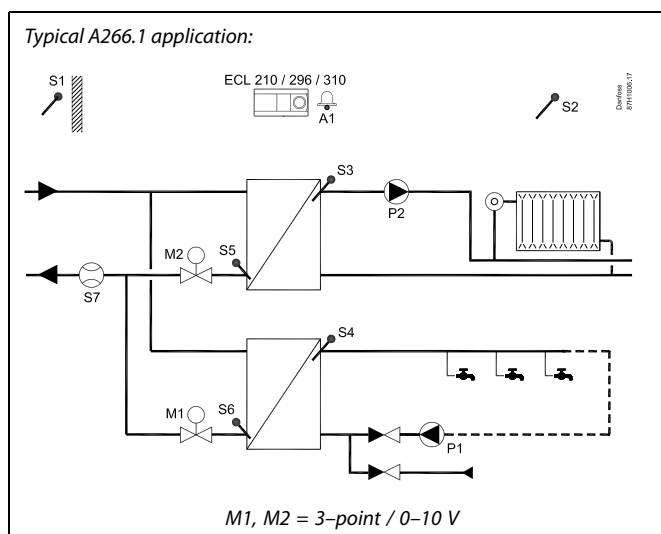

The shown diagram is a fundamental and simplified example and does not contain all components that are necessary in a system.

All named components are connected to the ECL Comfort controller.

List of components:

ECL 210/296 Electronic controller ECL Comfort 210, 296 or 310 / 310

S1	Outdoor temperature sensor
S2	(Optional) Room temperature sensor
S3	Flow temperature sensor, circuit 1
S4	DHW flow temperature sensor, circuit 2
S5	(Optional) Return temperature sensor, circuit 1
S6	(Optional) DHW return temperature sensor, circuit 2
S7	(Optional) Flow / energy meter (pulse signal)
P1	Circulation pump, DHW, circuit 2
P2	Circulation pump, heating, circuit 1
M1	Motorized control valve (3-point controlled), circuit 2
M2	Motorized control valve (3-point controlled), circuit 1 Alternative: Thermo actuator (Danfoss type ABV)
A1	Alarm
V1	Motorized control valve (0–10 V) (ECL Comfort 310 + ECA 32 only)
V2	Motorized control valve (0–10 V) (ECL Comfort 310 + ECA 32 only)

Operating Guide ECL Comfort 210 / 296 / 310, application A266

An anti-bacteria function is available for activation on selected days of the week.

If the desired DHW temperature cannot be reached, the heating circuit can be closed gradually to allow more energy to the DHW circuit.

A266.1, in general:

Alarm A1 (= relay 4) can be activated if the actual flow temperature differs from the desired flow temperature.

Holiday programs are present for Heating and DHW. Besides, a holiday program is present for the entire controller.

When the subtype A266.1 has been uploaded, the ECL Comfort controller starts in manual mode. This can be used for checking the controlled components for correct functionality.

Operating Guide ECL Comfort 210 / 296 / 310, application A266

The application **A266.2** is very flexible. These are the basic principles:

Heating (circuit 1):

Typically, the flow temperature is adjusted according to your requirements. The flow temperature sensor (S3) is the most important sensor. The desired flow temperature at S3 is calculated in the ECL controller, based on the outdoor temperature (S1) and the desired room temperature. The lower the outdoor temperature, the higher the desired flow temperature.

By means of a week schedule, the heating circuit can be in 'Comfort' or 'Saving' mode (two values for the desired room temperature). In Saving mode the heating can be reduced or switched off totally.

The motorized control valve (M2) is opened gradually when the flow temperature is lower than the desired flow temperature and vice versa.

The return temperature (S5) can be limited, for example not to be too high. If so, the desired flow temperature at S3 can be adjusted (typically to a lower value), thus resulting in a gradual closing of the motorized control valve. Furthermore, the return temperature limitation can be dependent on the outdoor temperature. Typically, the lower the outdoor temperature, the higher the accepted return temperature.

In boiler-based heating supply the return temperature should not be too low (same adjustment procedure as above).

If the measured room temperature does not equal the desired room temperature, the desired flow temperature can be adjusted. The circulation pump, P2, is ON at heat demand or at frost protection.

The heating can be switched OFF when the outdoor temperature is higher than a selectable value.

A connected flow or energy meter based on pulses (S7) can limit the flow or energy to a set maximum value. Furthermore the limitation can be in relation to the outdoor temperature. Typically, the lower the outdoor temperature, the higher the accepted flow / power. When the A266.2 is used in an ECL Comfort 310 the flow / energy signal can alternatively come as an M-bus signal.

The frost protection mode maintains a selectable flow temperature, for example 10 °C.

DHW (circuit 2):

The DHW temperature at S4 is maintained at 'Comfort' level at a DHW draw-off (DHW tapping) (the flow switch (S8) is activated). If the measured DHW temperature (S4) is lower than the desired DHW temperature, the motorized control valve (M1) is opened gradually and vice versa.

The DHW temperature control is in relation to actual supply temperature (S6). In order to compensate for the reaction time, the motorized control valve can be pre-activated at the start of a DHW draw-off (DHW tapping). An idle temperature can be maintained at either S6 or S4 when there is no draw-off (DHW tapping).

The return temperature (S5) can be limited to a fixed value.

By means of a week schedule, the DHW circuit can be in 'Comfort' or 'Saving' mode (two values for the desired DHW temperature).

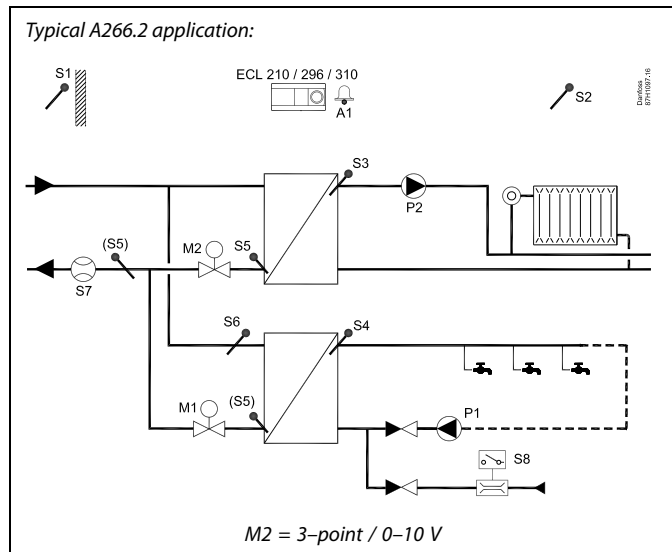

The shown diagram is a fundamental and simplified example and does not contain all components that are necessary in a system.

All named components are connected to the ECL Comfort controller.

List of components:

ECL 210 / 296 Electronic controller ECL Comfort 210, 296 or 310 / 310

S1	Outdoor temperature sensor
S2	(Optional) Room temperature sensor
S3	Flow temperature sensor, circuit 1
S4	DHW flow temperature sensor, circuit 2
S5	(Optional) Return temperature sensor, circuit 1, circuit 2 or both circuits
S6	(Optional) Supply temperature sensor, circuit 2
S7	(Optional) Flow / energy meter (pulse signal)
S8	Flow switch, DHW draw-off, circuit 2
P1	Circulation pump, DHW, circuit 2
P2	Circulation pump, heating, circuit 1
M1	Motorized control valve (3-point controlled), circuit 2
M2	Motorized control valve (3-point controlled), circuit 1 Alternative: Thermo actuator (Danfoss type ABV)
A1	Alarm
V2	Motorized control valve (0-10 V) (ECL Comfort 310 + ECA 32 only)

Operating Guide ECL Comfort 210 / 296 / 310, application A266

An anti-bacteria function is available for activation on selected days of the week.

If the desired DHW temperature cannot be reached, the heating circuit can be closed gradually to allow more energy to the DHW circuit.

A266.2, in general:

Alarm A1 (= relay 4) can be activated:

- if the actual flow temperature differs from the desired flow temperature
- if the temperature at S3 exceeds an alarm value

Holiday programs are present for Heating and DHW. Besides, a holiday program is present for the entire controller.

If the temperature at S3 exceeds the alarm value 'Max. flow T', the circulation pump P2 is switched OFF after elapse of the 'Delay'. P2 is switched ON again when the temperature at S3 gets below alarm value.

When the subtype A266.2 has been uploaded, the ECL Comfort controller starts in manual mode. This can be used for checking the controlled components for correct functionality.

Operating Guide ECL Comfort 210 / 296 / 310, application A266

The application **A266.9** is very flexible. These are the basic principles:

Heating (circuit 1):

Typically, the flow temperature is adjusted according to your requirements. The flow temperature sensor (S3) is the most important sensor. The desired flow temperature at S3 is calculated in the ECL controller, based on the outdoor temperature (S1) and the desired room temperature. The lower the outdoor temperature, the higher the desired flow temperature.

By means of a week schedule, the heating circuit can be in 'Comfort' or 'Saving' mode (two values for the desired room temperature). In Saving mode the heating can be reduced or switched off totally.

The motorized control valve (M2) is opened gradually when the flow temperature is lower than the desired flow temperature and vice versa.

The return temperature (S5) can be limited, for example not to be too high. If so, the desired flow temperature at S3 can be adjusted (typically to a lower value), thus resulting in a gradual closing of the motorized control valve. Furthermore, the return temperature limitation can be dependent on the outdoor temperature. Typically, the lower the outdoor temperature, the higher the accepted return temperature.

In boiler-based heating supply the return temperature should not be too low (same adjustment procedure as above).

The circulation pump, P2, is ON at heat demand or at frost protection.

The heating can be switched OFF when the outdoor temperature is higher than a selectable value.

The secondary return temperature (S2) is used for monitoring. The pressure measuring (S7) is used to activate an alarm if the actual pressure is higher or lower than the chosen settings.

When the A266.9 is used in an ECL Comfort 310, a connected flow or energy meter based on M-bus signal can limit the flow or energy to a set maximum value. Furthermore the limitation can be in relation to the outdoor temperature. Typically, the lower the outdoor temperature, the higher the accepted flow / power.

The frost protection mode maintains a selectable flow temperature, for example 10 °C.

DHW (circuit 2):

If the measured DHW temperature (S4) is lower than the desired DHW temperature, the motorized control valve (M1) is opened gradually and vice versa. If the desired DHW temperature cannot be reached, the heating circuit can be closed gradually to allow more energy to the DHW circuit.

The return temperature S6 can measure, for monitoring purpose, the return temperature on the secondary side. An alternative position for S6 can be in the return on the primary side in order to limit the return temperature to a fixed value.

By means of a week schedule, the DHW circuit can be in 'Comfort' or 'Saving' mode (two values for the desired DHW temperature).

If the desired DHW temperature cannot be reached, the heating circuit can be closed gradually to allow more energy to the DHW circuit.

An anti-bacteria function is available for activation on selected days of the week.

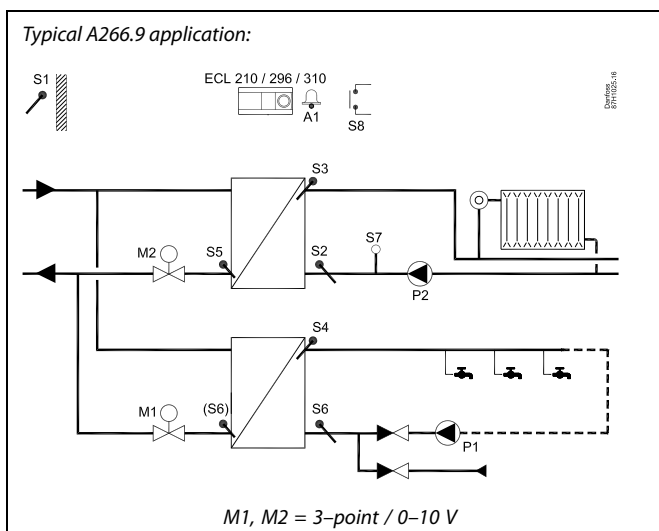

The shown diagram is a fundamental and simplified example and does not contain all components that are necessary in a system.

All named components are connected to the ECL Comfort controller.

List of components:

ECL 210 / 296 / 310	Electronic controller ECL Comfort 210, 296 or 310 / 310
S1	Outdoor temperature sensor
S2	(Optional) Return temperature sensor, circuit 1, for monitoring
S3	Flow temperature sensor, circuit 1
S4	DHW flow temperature sensor, circuit 2
S5	(Optional) Return temperature sensor, circuit 1
S6	(Optional) Return temperature sensor, secondary side, circuit 2. Alternative position: Return, primary side
S7	(Optional) Pressure transmitter, circuit 1
S8	(Optional) Alarm input
P1	Circulation pump, DHW, circuit 2
P2	Circulation pump, heating, circuit 1
M1	Motorized control valve, circuit 2
M2	Motorized control valve, circuit 1
A1	Alarm
V1	Motorized control valve (0-10 V) (ECL Comfort 310 + ECA 32 only)
V2	Motorized control valve (0-10 V) (ECL Comfort 310 + ECA 32 only)

Operating Guide ECL Comfort 210 / 296 / 310, application A266

A266.9, in general:

Alarm A1 (= relay 4) can be activated:

- if the temperature at S3 exceeds an alarm value
- if the pressure at S7 is not inside an acceptable pressure range
- if the alarm input S8 is activated

If the temperature at S3 exceeds the alarm value 'Max. flow T', the circulation pump P2 is switched OFF after elapse of the 'Delay'. P2 is switched ON again when the temperature at S3 gets below alarm value.

When the subtype A266.9 has been uploaded, the ECL Comfort controller starts in scheduled mode.

Operating Guide ECL Comfort 210 / 296 / 310, application A266

The application **A266.10** is very flexible. These are the basic principles:

Heating (circuit 1):

Typically, the flow temperature is adjusted according to your requirements. The flow temperature sensor (S3) is the most important sensor. The desired flow temperature at S3 is calculated in the ECL controller, based on the outdoor temperature (S1) and the desired room temperature. The lower the outdoor temperature, the higher the desired flow temperature.

By means of a week schedule, the heating circuit can be in 'Comfort' or 'Saving' mode (two values for the desired room temperature). In Saving mode the heating can be reduced or switched off totally.

The motorized control valve (M2) is opened gradually when the flow temperature is lower than the desired flow temperature and vice versa.

The return temperature (S5) can be limited, for example not to be too high. If so, the desired flow temperature at S3 can be adjusted (typically to a lower value), thus resulting in a gradual closing of the motorized control valve. Furthermore, the return temperature limitation can be dependent on the outdoor temperature. Typically, the lower the outdoor temperature, the higher the accepted return temperature.

In boiler-based heating supply the return temperature should not be too low (same adjustment procedure as above).

The circulation pump, P2, is ON at heat demand or at frost protection.

The heating can be switched OFF when the outdoor temperature is higher than a selectable value.

The secondary return temperature (S2) is used for monitoring. A connected flow or energy meter based on pulses (S7) can limit the flow or energy to a set maximum value. Furthermore the limitation can be in relation to the outdoor temperature. Typically, the lower the outdoor temperature, the higher the accepted flow / power.

When the A266.10 is used in an ECL Comfort 310 the flow / energy signal can alternatively come as an M-bus signal.

The frost protection mode maintains a selectable flow temperature, for example 10 °C.

DHW (circuit 2):

If the measured DHW temperature (S4) is lower than the desired DHW temperature, the motorized control valve (M1) is opened gradually and vice versa. If the desired DHW temperature cannot be reached, the heating circuit can be closed gradually to allow more energy to the DHW circuit.

The return temperature S6 can measure, for monitoring purpose, the return temperature on the secondary side. An alternative position for S6 can be in the return on the primary side in order to limit the return temperature to a fixed value.

By means of a week schedule, the DHW circuit can be in 'Comfort' or 'Saving' mode (two values for the desired DHW temperature).

If the desired DHW temperature cannot be reached, the heating circuit can be closed gradually to allow more energy to the DHW circuit.

An anti-bacteria function is available for activation on selected days of the week.

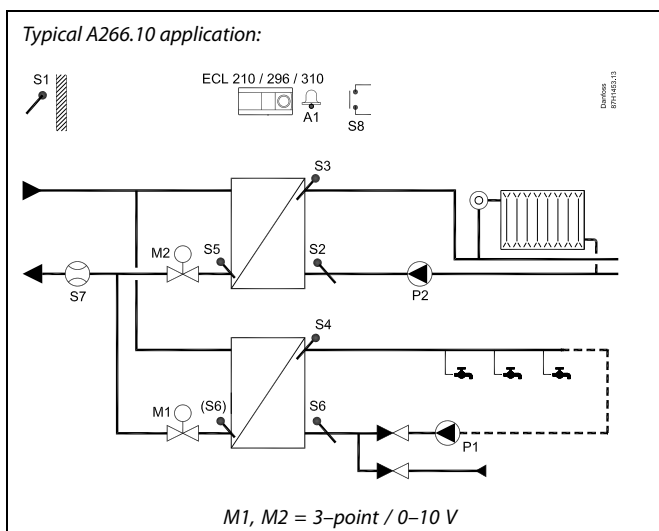

The shown diagram is a fundamental and simplified example and does not contain all components that are necessary in a system.

All named components are connected to the ECL Comfort controller.

List of components:

ECL 210 / 296 / 310	Electronic controller ECL Comfort 210, 296 or 310 / 310
S1	Outdoor temperature sensor
S2	(Optional) Return temperature sensor, circuit 1, for monitoring
S3	Flow temperature sensor, circuit 1
S4	DHW flow temperature sensor, circuit 2
S5	(Optional) Return temperature sensor, circuit 1
S6	(Optional) Return temperature sensor, secondary side, circuit 2. Alternative position: Return, primary side
S7	(Optional) Flow / energy meter (pulse signal)
S8	(Optional) Alarm input
P1	Circulation pump, DHW, circuit 2
P2	Circulation pump, heating, circuit 1
M1	Motorized control valve, circuit 2
M2	Motorized control valve, circuit 1
A1	Alarm
V1	Motorized control valve (0-10 V) (ECL Comfort 310 + ECA 32 only)
V2	Motorized control valve (0-10 V) (ECL Comfort 310 + ECA 32 only)

Operating Guide ECL Comfort 210 / 296 / 310, application A266

A266.10, in general:

Alarm A1 (= relay 4) can be activated:

- if the temperature at S3 exceeds an alarm value
- if the alarm input S8 is activated

If the temperature at S3 exceeds the alarm value 'Max. flow T', the circulation pump P2 is switched OFF after elapse of the 'Delay'. P2 is switched ON again when the temperature at S3 gets below alarm value.

When the subtype A266.10 has been uploaded, the ECL Comfort controller starts in scheduled mode.

A266, in general:

Up to two Remote Control Units, ECA 30 / 31 can be connected to one ECL controller in order to control the ECL controller remotely.

Exercise of circulation pumps and control valve in periods without heating demand can be arranged.

Additional ECL Comfort controllers can be connected via the ECL 485 bus in order to utilize common outdoor temperature signal, time and date signals. The ECL controllers in the ECL 485 system can work in master - slave system.

Unused input can, by means of an override switch, be used to override the schedule to a fixed 'Comfort' or 'Saving' mode.

Modbus communication to a SCADA system can be established.

The M-bus data (ECL Comfort 310) can furthermore be transferred to the Modbus communication.

Alarm A1 (= relay 4) can be activated:

- if a temperature sensor or its connection disconnects / short circuits. (See: Common controller settings > System > Raw input overview).



The controller is pre-programmed with factory settings that are shown in the 'Parameter ID overview' appendix.

2.2 Identifying the system type

Sketch your application

The ECL Comfort controller series is designed for a wide range of heating, domestic hot-water (DHW) and cooling systems with different configurations and capacities. If your system differs from the diagrams shown here, you may want to make a sketch of the system about to be installed. This makes it easier to use the Operating Guide, which will guide you step-by-step from installation to final adjustments before the end-user takes over.

The ECL Comfort controller is a universal controller that can be used for various systems. Based on the shown standard systems, it is possible to configure additional systems. In this chapter you find the most frequently used systems. If your system is not quite as shown below, find the diagram which has the best resemblance with your system and make your own combinations.

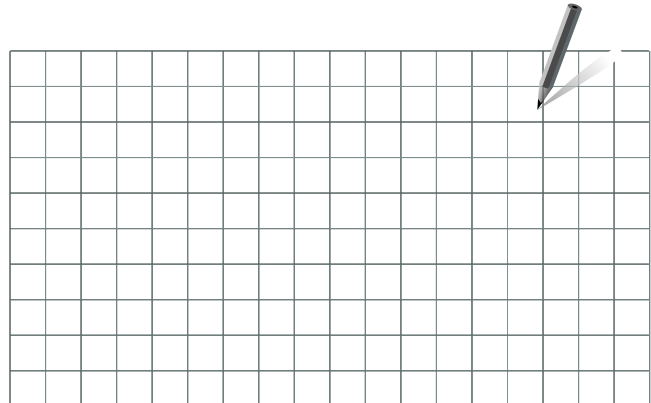

See the Installation Guide (delivered with the application key) for application types / sub-types.



The circulation pump(s) in heating circuit(s) can be placed in the flow as well as the return. Place the pump according to the manufacturer's specification.

Operating Guide ECL Comfort 210 / 296 / 310, application A266

2.3 Mounting

2.3.1 Mounting the ECL Comfort controller

See the Installation Guide which is delivered together with the ECL Comfort controller.

For easy access, you should mount the ECL Comfort controller near the system.

ECL Comfort 210 / 296 / 310 can be mounted

- on a wall
- on a DIN rail (35 mm)

ECL Comfort 296 can be mounted

- in a panel cut-out

ECL Comfort 210 can be mounted in an ECL Comfort 310 base part (for future upgrade).

Screws, PG cable glands and rawplugs are not supplied.

Locking the ECL Comfort 210 / 310 controller

In order to fasten the ECL Comfort controller to its base part, secure the controller with the locking pin.

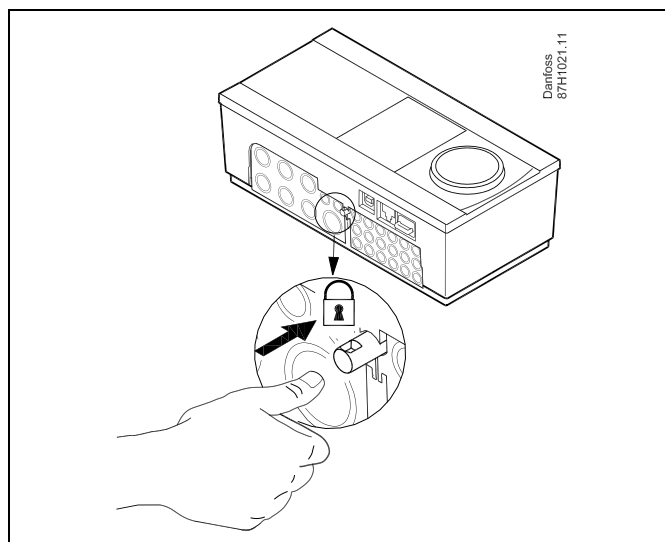

To prevent injuries to persons or the controller, the controller has to be securely locked into the base. For this purpose, press the locking pin into the base until a click is heard and the controller no longer can be removed from the base.



If the controller is not securely locked into the base part, there is a risk that the controller during operation can unlock from the base and the base with terminals (and also the 230 V a.c. connections) are exposed. To prevent injuries to persons, always make sure that the controller is securely locked into its base. If this is not the case, the controller should not be operated!



The easy way to lock the controller to its base or unlock it is to use a screw driver as lever.

Mounting on a wall

Mount the base part on a wall with a smooth surface. Establish the electrical connections and position the controller in the base part. Secure the controller with the locking pin.

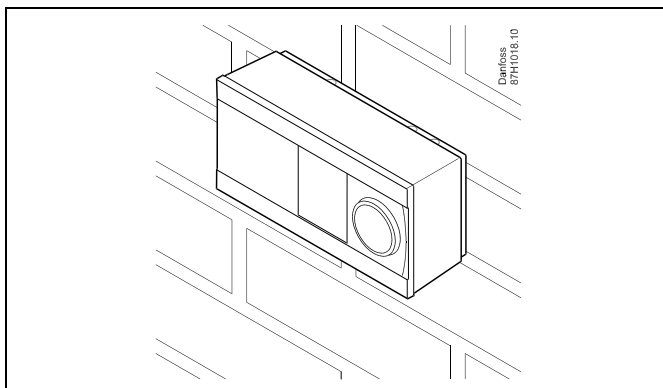

Mounting on a DIN rail (35 mm)

Mount the base part on a DIN rail. Establish the electrical connections and position the controller in the base part. Secure the controller with the locking pin.

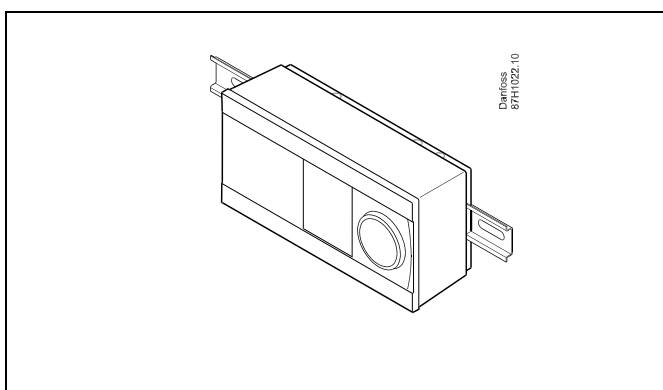

Dismounting the ECL Comfort controller

In order to remove the controller from the base part, pull out the locking pin by means of a screwdriver. The controller can now be removed from the base part.

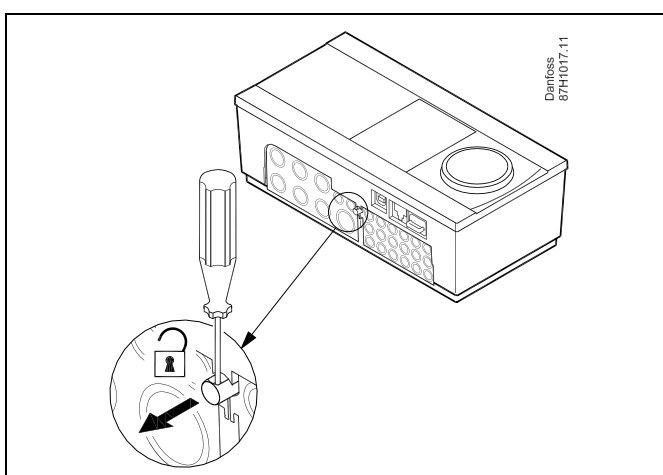

The easy way to lock the controller to its base or unlock it is to use a screw driver as lever.



Before removing the ECL Comfort controller from the base part, ensure that the supply voltage is disconnected.

2.3.2 Mounting the Remote Control Units ECA 30 / 31

Select one of the following methods:

- Mounting on a wall, ECA 30 / 31
- Mounting in a panel, ECA 30

Screws and rawlplugs are not supplied.

Mounting on a wall

Mount the base part of the ECA 30 / 31 on a wall with a smooth surface. Establish the electrical connections. Place the ECA 30 / 31 in the base part.

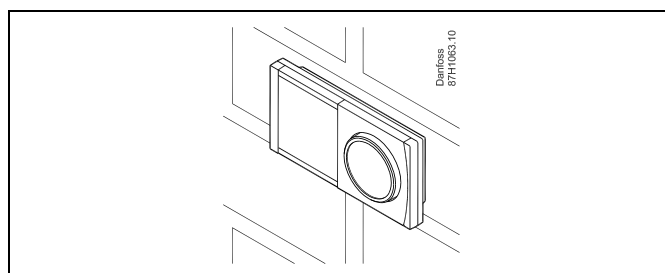

Mounting in a panel

Mount the ECA 30 in a panel using the ECA 30 frame kit (order code no. 087H3236). Establish the electrical connections. Secure the frame with the clamp. Place the ECA 30 in the base part. The ECA 30 can be connected to an external room temperature sensor.

The ECA 31 must not be mounted in a panel if the humidity function is to be used.

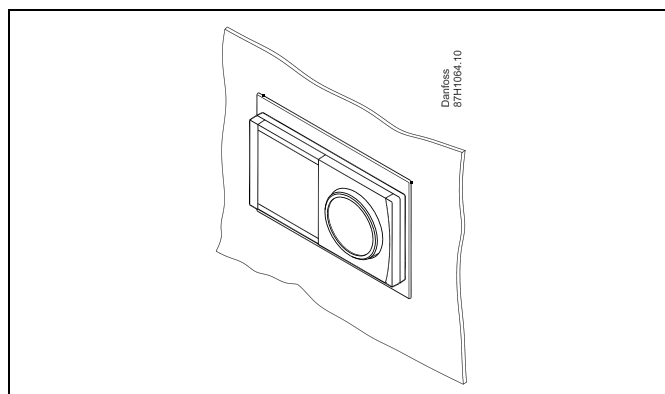

Operating Guide ECL Comfort 210 / 296 / 310, application A266

2.3.3 Mounting the internal I/O module ECA 32

Mounting of the internal I/O module ECA 32

The ECA 32 module (order code no. 087H3202) must be inserted into the ECL Comfort 310 / 310B base part for additional input and output signals in relevant applications.

The connection between the ECL Comfort 310 / 310B and ECA 32 is a 10-pole (2 x 5) connector. The connection is automatically established when the ECL Comfort 310 / 310B is placed on the base part.

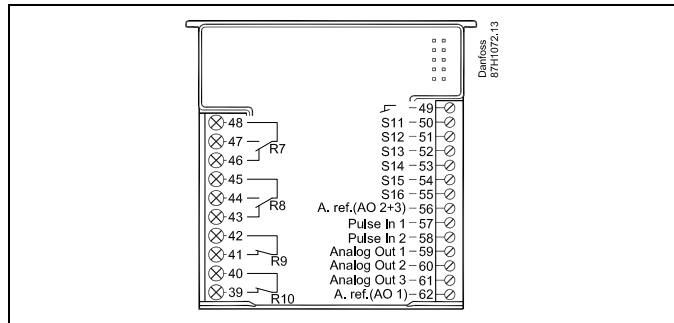
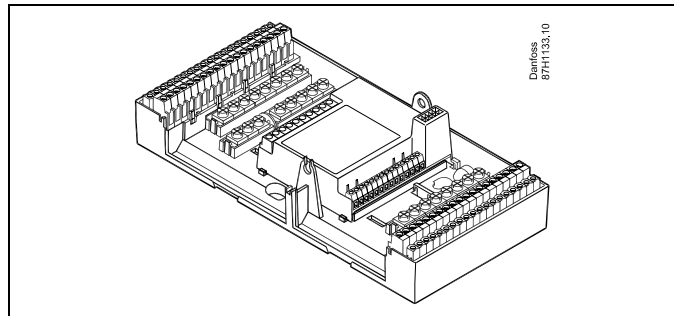

Operating Guide ECL Comfort 210 / 296 / 310, application A266

2.4 Placing the temperature sensors

2.4.1 Placing the temperature sensors

It is important that the sensors are mounted in the correct position in your system.

The temperature sensor mentioned below are sensors used for the ECL Comfort 210 / 296 / 310 series which not all will be needed for your application!

Outdoor temperature sensor (ESMT)

The outdoor sensor should be mounted on that side of the building where it is less likely to be exposed to direct sunshine. It should not be placed close to doors, windows or air outlets.

Flow temperature sensor (ESMU, ESM-11 or ESMC)

Place the sensor max. 15 cm from the mixing point. In systems with heat exchanger, Danfoss recommends that the ESMU-type to be inserted into the exchanger flow outlet.

Make sure that the surface of the pipe is clean and even where the sensor is mounted.

Return temperature sensor (ESMU, ESM-11 or ESMC)

The return temperature sensor should always be placed so that it measures a representative return temperature.

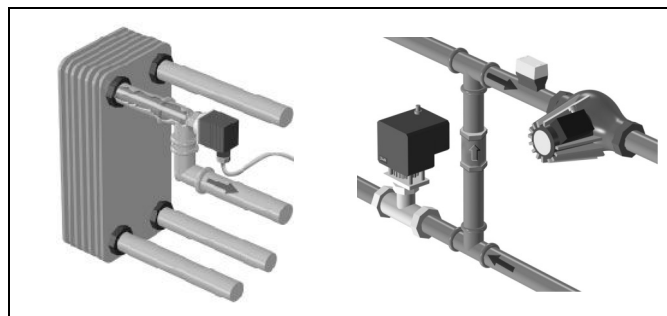

Room temperature sensor (ESM-10, ECA 30 / 31 Remote Control Unit)

Place the room sensor in the room where the temperature is to be controlled. Do not place it on outside walls or close to radiators, windows or doors.

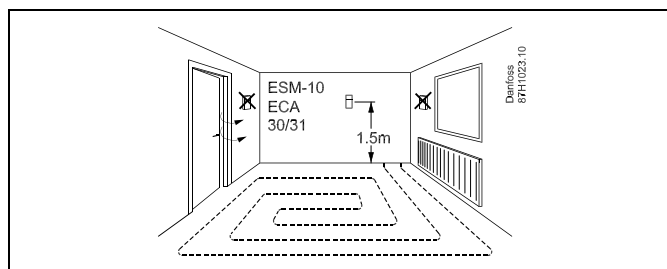

Boiler temperature sensor (ESMU, ESM-11 or ESMC)

Place the sensor according to the boiler manufacturer's specification.

Air duct temperature sensor (ESMB-12 or ESMU types)

Place the sensor so that it measures a representative temperature.

DHW temperature sensor (ESMU or ESMB-12)

Place the DHW temperature sensor according to the manufacturer's specification.

Slab temperature sensor (ESMB-12)

Place the sensor in a protection tube in the slab.



ESM-11: Do not move the sensor after it has been fastened in order to avoid damage to the sensor element.



ESM-11, ESMC and ESMB-12: Use heat conducting paste for quick measurement of the temperature.



ESMU and ESMB-12: Using a sensor pocket to protect the sensor will, however, result in a slower temperature measurement.

Operating Guide ECL Comfort 210 / 296 / 310, application A266

Pt 1000 temperature sensor (IEC 751B, 1000 Ω / 0 °C)

Relationship between temperature and ohmic value:

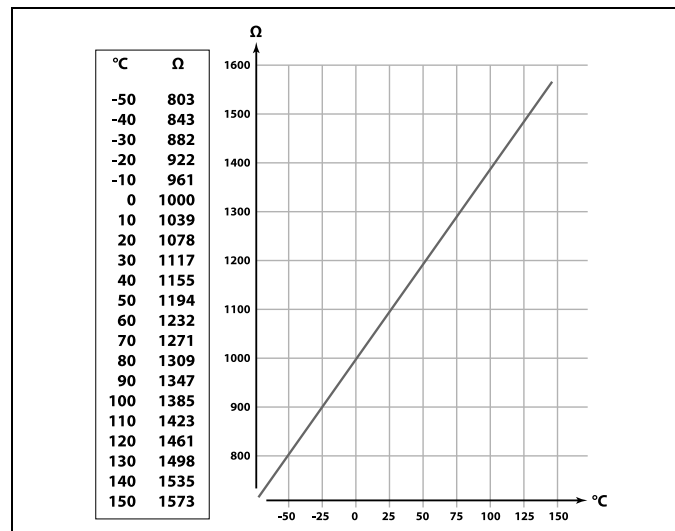

Operating Guide ECL Comfort 210 / 296 / 310, application A266

2.5 Electrical connections

2.5.1 Electrical connections 230 V a.c.

**Warning**

Electric conductors on PCB (Printed Circuit Board) for supply voltage, relay contacts and triac outputs do not have mutual safety distance of minimum 6 mm. The outputs are not allowed to be used as galvanic separated (voltage free) outputs.

If a galvanic separated output is needed, an auxiliary relay is recommended.

24 Volt controlled units, for example actuators, are to be controlled by means of ECL Comfort 310, 24 Volt version.

**Safety Note**

Necessary assembly, start-up, and maintenance work must be performed by qualified and authorized personnel only.

Local legislations must be respected. This comprises also cable size and isolation (reinforced type).

A fuse for the ECL Comfort installation is max. 10 A typically.

The ambient temperature range for the ECL Comfort in operation is 0 - 55 °C. Exceeding this temperature range can result in malfunctions.

Installation must be avoided if there is a risk for condensation (dew).

Operating Guide ECL Comfort 210 / 296 / 310, application A266

The common ground terminal is used for connection of relevant components (pumps, motorized control valves).

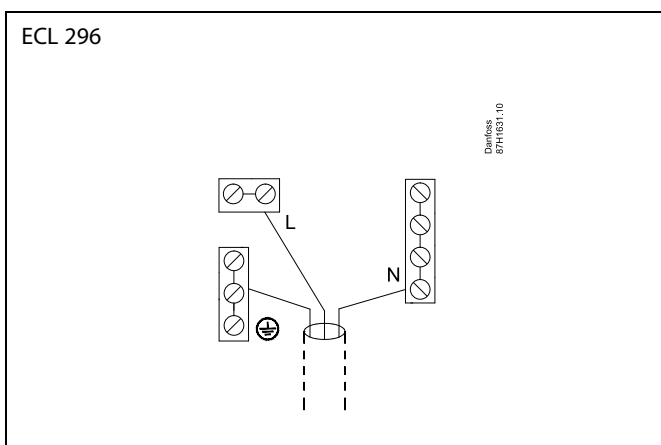
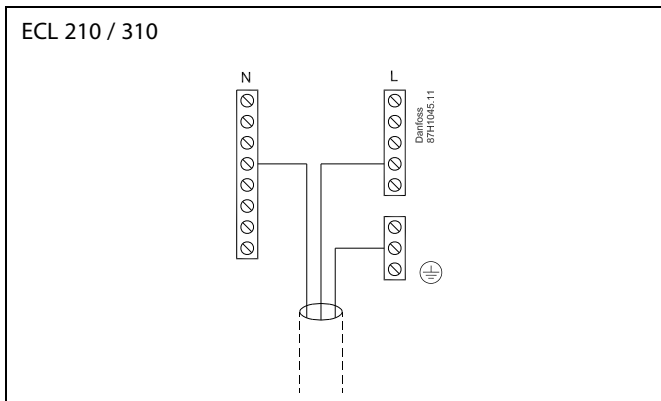

See also the Installation Guide (delivered with the application key) for application specific connections.



Wire cross section: 0.5 - 1.5 mm²
 Incorrect connection can damage the electronic outputs.
 Max. 2 x 1.5 mm² wires can be inserted into each screw terminal.

Maximum load ratings:



R	Relay terminals	4 (2) A / 230 V a.c. (4 A for ohmic load, 2 A for inductive load)
Tr	Triac (= electronic relay) terminals	0,2 A / 230 V a.c.

Operating Guide ECL Comfort 210 / 296 / 310, application A266

2.5.2 Electrical connections 24 V a.c.

See also the Installation Guide (delivered with the application key) for application specific connections.

Maximum load ratings:

R  R 	Relay terminals	4 (2) A / 24 V a.c. (4 A for ohmic load, 2 A for inductive load)
Tr 	Triac (= electronic relay) terminals	1 A / 24 V a.c.



Do not connect 230 V a.c. powered components to a 24 V a.c. power supplied controller directly. Use auxiliary relays (K) to separate 230 V a.c. from 24 V a.c.

2.5.3 Electrical connections, safety thermostats, in general

See also the Installation Guide (delivered with the application key) for application specific connections.



When ST is activated by a high temperature, the safety circuit in the motorized control valve closes the valve immediately.



When ST1 is activated by a high temperature (the TR temperature), the motorized control valve is closed gradually. At a higher temperature (the ST temperature), the safety circuit in the motorized control valve closes the valve immediately.

Operating Guide ECL Comfort 210 / 296 / 310, application A266

2.5.4 Electrical connections, Pt 1000 temperature sensors and signals

See the Installation Guide (delivered with the application key) for sensor and input connections.

Sensor	Description	Recommended type
S1	Outdoor temperature sensor *	ESMT
S2	A266.1, A266.2: Room temperature sensor ** Alternative: ECA 30 / 31	A266.1, A266.2: ESM-10
	A266.9, A266.10: Return temperature sensor (heating, secondary side)	ESM-11 / ESMB / ESMC / ESMU
S3	Flow temperature sensor *** (heating)	ESM-11 / ESMB / ESMC / ESMU
S4	Flow temperature sensor *** (DHW)	ESM-11 / ESMB / ESMC / ESMU
S5	Return temperature sensor (heating)	ESM-11 / ESMB / ESMC / ESMU
(S5)	A266.2: Return temperature sensor, alternative positions	ESM-11 / ESMB / ESMC / ESMU
S6	A266.1, A266.9, A266.10: Return temperature sensor (DHW)	ESM-11 / ESMB / ESMC / ESMU
	A266.2: Supply temperature sensor	ESM-11 / ESMB / ESMC / ESMU
(S6)	A266.9, A266.10: Return temperature sensor, alternative position	ESM-11 / ESMB / ESMC / ESMU
S7	A266.1, A266.2, A266.10: Flow / heat meter (pulse signal)	
	A266.9: Pressure transmitter, 0 - 10 V or 4 - 20 mA	
S8	A266.2: Flow switch	
	A266.9, A266.10: Alarm contact / switch	

* If the outdoor temperature sensor is not connected or the cable is short-circuited, the controller assumes that the outdoor temperature is 0 (zero) °C.

** Only for room temperature sensor connection. The room temperature signal can also be available from a Remote Control Unit (ECA 30 / 31). See the Installation Guide (delivered with the application key) for specific connections.

*** The flow temperature sensor must always be connected in order to have the desired functionality. If the sensor is not connected or the cable is short-circuited, the motorized control valve closes (safety function).



Wire cross section for sensor connections: Min. 0.4 mm².
Total cable length: Max. 200 m (all sensors incl. internal ECL 485 communication bus).
Cable lengths of more than 200 m may cause noise sensibility (EMC).

Connection of flow meter

See the Installation Guide (delivered with the application key).

Connection of flow switch or alarm contact / switch

The alarm contact acts as a Normally Closed (NC) contact. The set-up can be changed to react on a Normally Open (NO) contact. See Circuit 1 > MENU > Alarm > Digital > Alarm value:

0 = Alarm for NO contact
1 = Alarm for NC contact

Connection of pressure transmitter

Scale for conversion of voltage to pressure is set in the ECL Comfort. The pressure transmitter is powered with 12 - 24 V d.c. Output types: 0 - 10 V or 4 - 20 mA. 4 - 20 mA signal is converted to a 2 - 10 V signal by means of a 500 ohm (0,5 W) resistor.

Operating Guide ECL Comfort 210 / 296 / 310, application A266

2.5.5 Electrical connections, ECA 30 / 31

Terminal ECL	Terminal ECA 30 / 31	Description	Type (recomm.)
30	4	Twisted pair	Cable 2 x twisted pair
31	1		
32	2	Twisted pair	
33	3		
	4	Ext. room temperature sensor*	ESM-10
	5		

* After an external room temperature sensor has been connected, ECA 30 / 31 must be repowered.

The communication to the ECA 30 / 31 must be set up in the ECL Comfort controller in 'ECA addr.'

The ECA 30 / 31 must be set up accordingly.

After application setup the ECA 30 / 31 is ready after 2–5 min. A progress bar in the ECA 30 / 31 is displayed.



If the actual application contains two heating circuits, it is possible to connect an ECA 30 / 31 to each circuit. The electrical connections are done in parallel.



Max. 2 ECA 30 / 31 can be connected to an ECL Comfort 310 controller or to ECL Comfort 210 / 296 / 310 controllers in a master-slave system.



Setup procedures for ECA 30 / 31: See section 'Miscellaneous'.



ECA information message:
'Application req. newer ECA':
The software (firmware) of your ECA does not comply with the software (firmware) of your ECL Comfort controller. Please contact your Danfoss sales office.



Some applications do not contain functions related to actual room temperature. The connected ECA 30 / 31 will only function as remote control.



Total cable length: Max. 200 m (all sensors incl. internal ECL 485 communication bus).
Cable lengths of more than 200 m may cause noise sensibility (EMC).

2.5.6 Electrical connections, master / slave systems

The controller can be used as master or slave in master / slave systems via the internal ECL 485 communication bus (2 x twisted pair cable).

The ECL 485 communication bus is not compatible with the ECL bus in ECL Comfort 110, 200, 300 and 301!

Terminal	Description	Type (recomm.)
30	Common terminal	Cable 2 x twisted pair
31	+12 V*, ECL 485 communication bus * Only for ECA 30 / 31 and master / slave communication	
32	B, ECL 485 communication bus	
33	A, ECL 485 communication bus	



ECL 485 bus cable

Maximum recommended length of the ECL 485 bus is calculated like this:

Subtract "Total length of all input cables of all ECL controllers in the master - slave system" from 200 m.

Simple example for total length of all input cables, 3 x ECL:

1 x ECL	Outdoor temp. sensor:	15 m
3 x ECL	Flow temp. sensor:	18 m
3 x ECL	Return temp. sensor:	18 m
3 x ECL	Room temp. sensor:	30 m
Total:		81 m

Maximum recommended length of the ECL 485 bus:
200 - 81 m = 119 m

2.5.7 Electrical connections, communication

Electrical connections, Modbus

ECL Comfort 210: Non-galvanic isolated Modbus connections
ECL Comfort 296: Galvanic isolated Modbus connections
ECL Comfort 310: Galvanic isolated Modbus connections

2.5.8 Electrical connections, communication

Electrical connections, M-bus

ECL Comfort 210: Not implemented

ECL Comfort 296: On board, non-galvanic isolated. Max. cable length 50 m.

ECL Comfort 310: On board, non-galvanic isolated. Max. cable length 50 m.

Operating Guide ECL Comfort 210 / 296 / 310, application A266

2.6 Inserting the ECL Application Key

2.6.1 Inserting the ECL Application Key

The ECL Application Key contains

- the application and its subtypes,
- currently available languages,
- factory settings: e.g. schedules, desired temperatures, limitation values etc. It is always possible to recover the factory settings,
- memory for user settings: special user / system settings.

After having powered-up the controller, different situations might be existing:

1. The controller is new from the factory, the ECL Application Key is not inserted.
2. The controller already runs an application. The ECL Application Key is inserted, but the application needs to be changed.
3. A copy of the controllers settings is needed for configuring another controller.

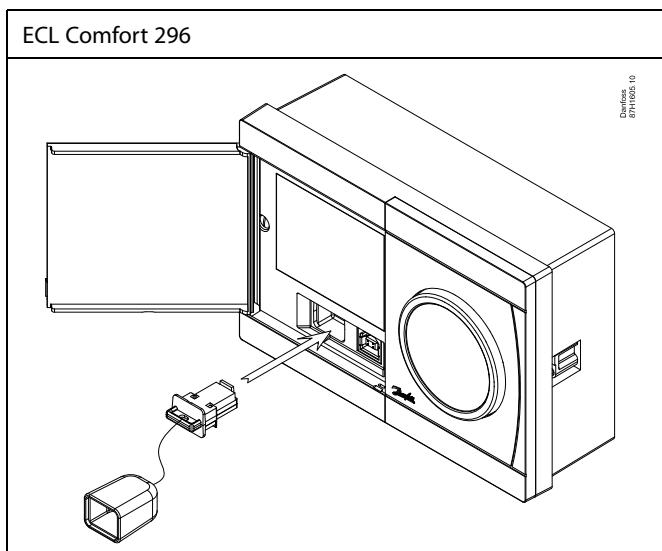
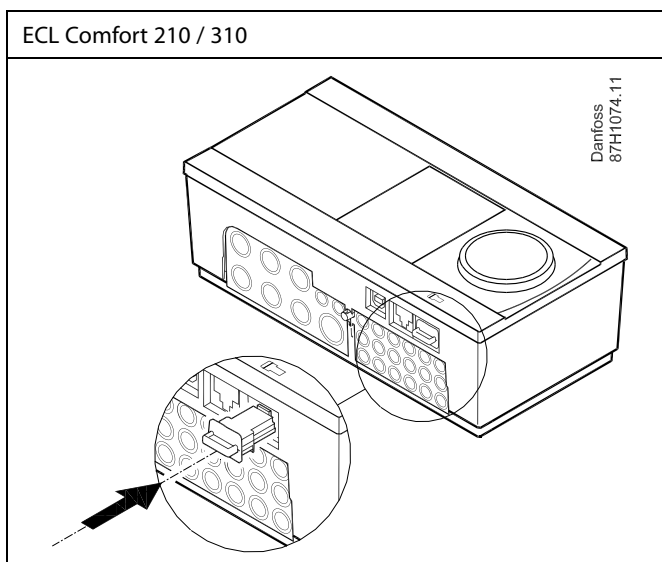
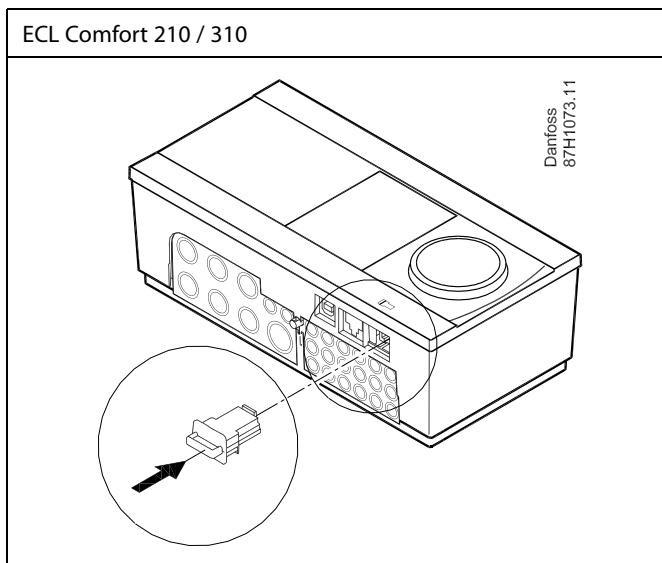

User settings are, among others, desired room temperature, desired DHW temperature, schedules, heat curve, limitation values etc.

System settings are, among others, communication set-up, display brightness etc.



Automatic update of controller software (firmware):

The software of the controller is updated automatically when the key is inserted (as of controller version 1.11 (ECL 210 / 310) and version 1.58 (ECL 296)). The following animation will be shown when the software is being updated:

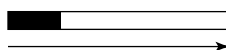

Progress bar

During update:

- Do not remove the KEY
If the key is removed before the hour-glass is shown, you have to start afresh.
- Do not disconnect the power
If the power is interrupted when the hour-glass is shown, the controller will not work.
- Manual update of controller software (firmware):
See the section "Automatic / manual update of firmware"



The "Key overview" does not inform — through ECA 30 / 31 — about the subtypes of the application key.



Key inserted / not inserted, description:

ECL Comfort 210 / 310, controller versions lower than 1.36:

- Take out the application key; for 20 minutes settings can be changed.
- Power up the controller **without** the application key inserted; for 20 minutes settings can be changed.

ECL Comfort 210 / 310, controller versions 1.36 and up:

- Take out the application key; for 20 minutes settings can be changed.
- Power up the controller **without** the application key inserted; settings cannot be changed.

ECL Comfort 296 , controller versions 1.58 and up:

- Take out the application key; for 20 minutes settings can be changed.
- Power up the controller **without** the application key inserted; settings cannot be changed.

Operating Guide ECL Comfort 210 / 296 / 310, application A266

Application Key: Situation 1

The controller is new from the factory, the ECL Application Key is not inserted.

An animation for the ECL Application Key insertion is displayed. Insert the Application Key.

Application Key name and Version is indicated (example: A266 Ver. 1.03).

If the ECL Application Key is not suitable for the controller, a "cross" is displayed over the ECL Application Key-symbol.



Action:	Purpose:	Examples:
	Select language	
	Confirm	
	Select application (subtype)	
	Some keys have only one application.	
	Confirm with 'Yes'	
	Set 'Time & Date'	
	Turn and push the dial to select and change 'Hours', 'Minutes', 'Date', 'Month' and 'Year'.	
	Choose "Next"	
	Confirm with 'Yes'	
	Go to 'Aut. daylight'	
	Choose whether 'Aut. daylight' * should be active or not	YES or NO

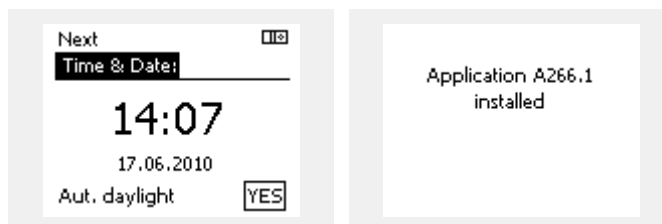
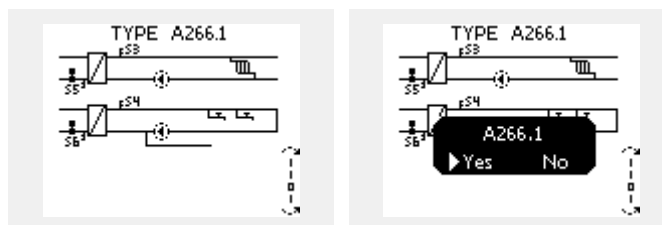
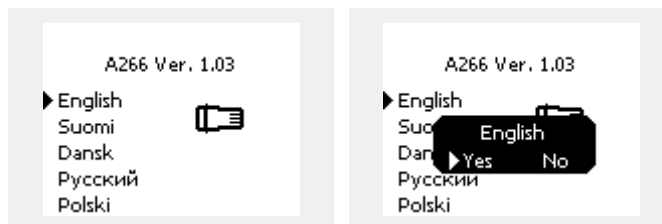

* 'Aut. daylight' is the automatic changeover between summer and winter time.

Depending on the contents of the ECL Application Key, procedure A or B is taking place:

A

The ECL Application key contains factory settings:

The controller reads / transfers data from the ECL Application Key to ECL controller.

The application is installed, and the controller resets and starts up.

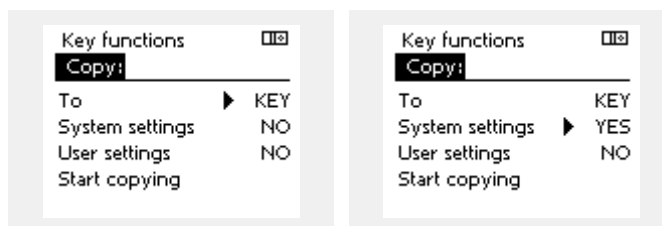

B

The ECL Application key contains changed system settings:

Push the dial repeatedly.

'NO': Only factory settings from the ECL Application Key will be copied to the controller.

'YES*': Special system settings (differing from the factory settings) will be copied to the controller.

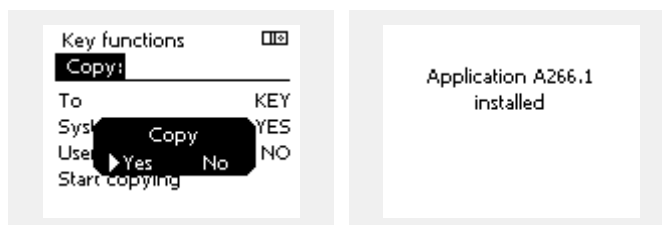

If the key contains user settings:

Push the dial repeatedly.

'NO': Only factory settings from the ECL Application Key will be copied to the controller.

'YES*': Special user settings (differing from the factory settings) will be copied to the controller.

* If 'YES' cannot be chosen, the ECL Application Key does not contain any special settings.

Choose 'Start copying' and confirm with 'Yes'.

Operating Guide ECL Comfort 210 / 296 / 310, application A266

(Example):

The "i" in the upper right corner indicates that - besides the factory settings - the subtype also contains special user / systems settings.

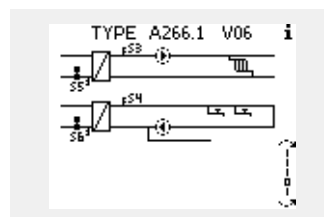

Application Key: Situation 2

The controller already runs an application. The ECL Application Key is inserted, but the application needs to be changed.

To change to another application on the ECL Application Key, the current application in the controller must be erased (deleted).

Be aware that the Application Key must be inserted.

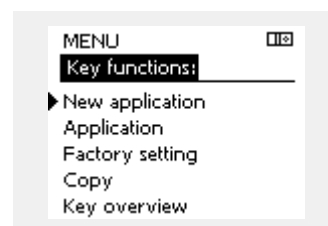
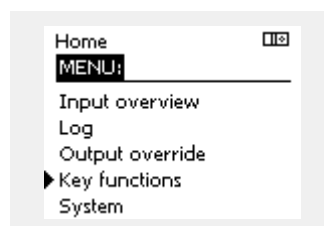

Action:	Purpose:	Examples:
	Choose 'MENU' in any circuit	MENU
	Confirm	
	Choose the circuit selector at the top right corner in the display	
	Confirm	
	Choose 'Common controller settings'	
	Confirm	
	Choose 'Key functions'	
	Confirm	
	Choose 'Erase application'	
	Confirm with 'Yes'	

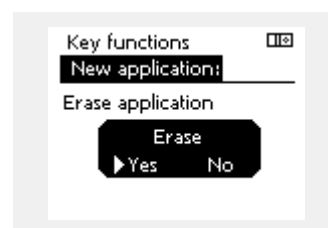
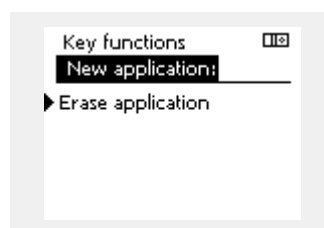

The controller resets and is ready to be configured.

Follow the procedure described in situation 1.

Operating Guide ECL Comfort 210 / 296 / 310, application A266

Application Key: Situation 3

A copy of the controllers settings is needed for configuring another controller.

This function is used

- for saving (backup) of special user and system settings
- when another ECL Comfort controller of the same type (210, 296 or 310) must be configured with the same application but user / system settings differ from the factory settings.

How to copy to another ECL Comfort controller:

Action:	Purpose:	Examples:
	Choose 'MENU'	MENU
	Confirm	
	Choose the circuit selector at the top right corner in the display	
	Confirm	
	Choose 'Common controller settings'	
	Confirm	
	Go to 'Key functions'	
	Confirm	
	Choose 'Copy'	
	Confirm	
	Choose 'To'. 'ECL' or 'KEY' will be indicated. Choose 'ECL' or 'KEY'	* 'ECL' or 'KEY'
	Push the dial repeatedly to choose copy direction	
	Choose 'System settings' or 'User settings'	** 'NO' or 'YES'
	Push the dial repeatedly to choose 'Yes' or 'No' in 'Copy'. Push to confirm.	
	Choose 'Start copying'	
	The Application Key or the controller is updated with special system or user settings.	

*

'ECL': Data will be copied from the Application Key to the ECL Controller.

'KEY': Data will be copied from the ECL Controller to the Application Key.

**

'NO': The settings from the ECL controller will not be copied to the Application Key or to the ECL Comfort controller.

'YES': Special settings (differing from the factory settings) will be copied to the Application Key or to the ECL Comfort controller. If YES can not be chosen, there are no special settings to be copied.

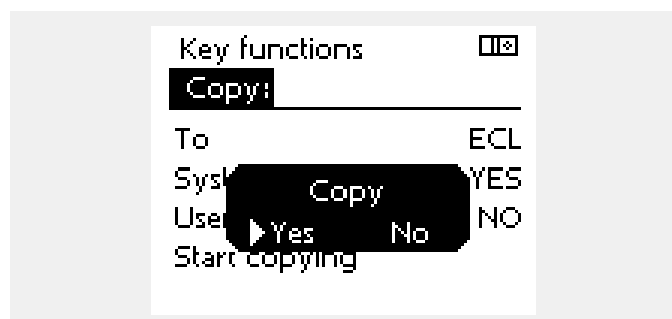
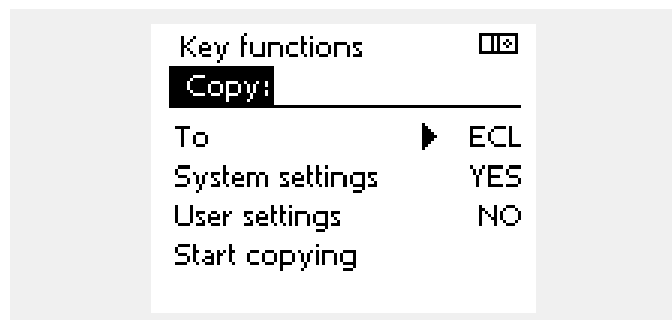
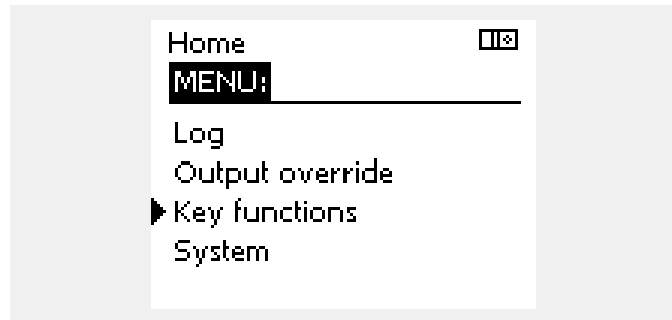

Operating Guide ECL Comfort 210 / 296 / 310, application A266

Language

At application upload, a language must be selected.*
 If another language than English is selected, the selected language **AND** English will be uploaded into the ECL controller.
 This makes service easy for English speaking service people, just because the English language menus can be visible by changing the actual set language into English.
 (Navigation: MENU > Common controller > System > Language)

If the uploaded language is not suitable, the application must be erased. User and System settings can be saved on the application key before erasing.
 After new upload with preferred language, the existing User and System settings can be uploaded.

*)
 (ECL Comfort 310, 24 Volt) If language cannot be selected, the power supply is not a.c. (alternating current).

2.6.2 ECL Application Key, copying data

General principles

When the controller is connected and operating, you can check and adjust all or some of the basic settings. The new settings can be stored on the Key.

How to update the ECL Application Key after settings have been changed?

All new settings can be stored on the ECL Application Key.

How to store factory setting in the controller from the Application Key?

Please read the paragraph concerning Application Key, Situation 1: The controller is new from the factory, the ECL Application Key is not inserted.

How to store personal settings from the controller to the Key?

Please read the paragraph concerning Application Key, Situation 3: A copy of the controllers settings is needed for configuring another controller

As a main rule, the ECL Application Key should always remain in the controller. If the Key is removed, it is not possible to change settings.



Factory settings can always be restored.



Make a note of new settings in the 'Settings overview' table.



Do not remove the ECL Application Key while copying. The data on the ECL Application Key can be damaged!



It is possible to copy settings from one ECL Comfort controller to another controller provided that the two controllers are from the same series (210 or 310).
 Furthermore, when the ECL Comfort controller has been uploaded with an application key, minimum version 2.44, it is possible to upload personal settings from application keys, minimum version 2.14.



The "Key overview" does not inform — through ECA 30 / 31 — about the subtypes of the application key.



Key inserted / not inserted, description:

ECL Comfort 210 / 310, controller versions lower than 1.36:

- Take out the application key; for 20 minutes settings can be changed.
- Power up the controller **without** the application key inserted; for 20 minutes settings can be changed.

ECL Comfort 210 / 310, controller versions 1.36 and up:

- Take out the application key; for 20 minutes settings can be changed.
- Power up the controller **without** the application key inserted; settings cannot be changed.

ECL Comfort 296 , controller versions 1.58 and up:

- Take out the application key; for 20 minutes settings can be changed.
- Power up the controller **without** the application key inserted; settings cannot be changed.

2.7 Check list



Is the ECL Comfort controller ready for use?

- Make sure that the correct power supply is connected to terminals 9 and 10 (230 V or 24 V).
- Make sure the correct phase conditions are connected:
230 V: Live = terminal 9 and Neutral = terminal 10
24 V: SP = terminal 9 and SN = terminal 10
- Check that the required controlled components (actuator, pump etc.) are connected to the correct terminals.
- Check that all sensors / signals are connected to the correct terminals (see 'Electrical connections').
- Mount the controller and switch on the power.
- Is the ECL Application Key inserted (see 'Inserting the Application Key').
- Does the ECL Comfort controller contain an existing application (see 'Inserting the Application Key').
- Is the correct language chosen (see 'Language' in 'Common controller settings').
- Is the time & date set correctly (see 'Time & Date' in 'Common controller settings').
- Is the right application chosen (see 'Identifying the system type').
- Check that all settings in the controller (see 'Settings overview') are set or that the factory settings comply with your requirements.
- Choose manual operation (see 'Manual control'). Check that valves open and close, and that required controlled components (pump etc.) start and stop when operated manually.
- Check that the temperatures / signals shown in the display match the actual connected components.
- Having completed the manual operation check, choose controller mode (scheduled, comfort, saving or frost protection).

Operating Guide ECL Comfort 210 / 296 / 310, application A266

2.8 Navigation, ECL Application Key A266

Navigation, A266.1, circuit 1 and 2

Home		Circuit 1, Heating		Circuit 2, DHW	
		ID no.	Function	ID no.	Function
MENU					
Schedule		Selectable		Selectable	
Settings	Flow temperature	11178	Heat curve	12178	Temp. max.
		11177	Temp. min.	12177	Temp. min.
		11004	Desired T		
	Room limit	11015	Adapt. time		
		11182	Infl. - max.		
		11183	Infl. - min.		
	Return limit			12030	Limit
		11031	High T out X1		
		11032	Low limit Y1		
		11033	Low T out X2		
11034		High limit Y2			
11035		Infl. - max.	12035	Infl. - max.	
11036		Infl. - min.	12036	Infl. - min.	
11037		Adapt. time	12037	Adapt. time	
11085		Priority	12085	Priority	
Flow / power limit				Actual	
			12111	Limit	
	11119	High T out X1			
	11117	Low limit Y1			
	11118	Low T out X2			
	11116	High limit Y2			
	11112	Adapt. time	12112	Adapt. time	
	11113	Filter constant	12113	Filter constant	
	11109	Input type	12109	Input type	
	11115	Units	12115	Units	
Optimization	11114	Pulse	12114	Pulse	
	11011	Auto saving			
	11012	Boost			
	11013	Ramp			
	11014	Optimizer			
	11026	Pre-stop			
	11020	Based on			
	11021	Total stop			
11179	Summer, cut-out				
	11043	Parallel operation			

Operating Guide ECL Comfort 210 / 296 / 310, application A266

Navigation, A266.1, circuit 1 and circuit 2 continued

Home MENU		Circuit 1, Heating		Circuit 2, DHW		
		ID no.	Function	ID no.	Function	
Settings	Control par.			12173	Auto tuning	
		11174	Motor pr.	12174	Motor pr.	
		11184	Xp	12184	Xp	
		11185	Tn	12185	Tn	
		11186	M run	12186	M run	
		11187	Nz	12187	Nz	
		11189	Min. act. time	12189	Min. act. time	
		11024	Actuator	12024	Actuator	
	Application		11010	ECA addr.		
			11017	Demand offset		
			11050	P demand		
			11500	Send desired T	12500	Send desired T
			11022	P exercise	12022	P exercise
			11023	M exercise	12023	M exercise
			11052	DHW priority		
			11077	P frost T	12077	P frost T
			11078	P heat T	12078	P heat T
			11040	P post-run	12040	P post-run
			11093	Frost pr. T	12093	Frost pr. T
			11141	Ext. input	12141	Ext. input
		11142	Ext. mode	12142	Ext. mode	
	Heat cut-out		11393	Sum. start, day		
			11392	Sum. start, month		
			11179	Summer, cut-out		
			11395	Summer, filter		
			11397	Winter start, day		
			11396	Win. start, month		
			11398	Winter, cut-out		
	Anti-bacteria					Day Start time Duration Desired T
	Holiday		Selectable		Selectable	
Alarm	Temp. monitoring	11147	Upper difference	12147	Upper difference	
		11148	Lower difference	12148	Lower difference	
		11149	Delay	12149	Delay	
		11150	Lowest temp.	12150	Lowest temp.	
Alarm overview		Selectable		Selectable		

Operating Guide ECL Comfort 210 / 296 / 310, application A266

Navigation, A266.1, circuit 1 and circuit 2 continued

Home MENU	Circuit 1, Heating		Circuit 2, DHW	
	ID no.	Function	ID no.	Function
Influence overview	Des. flow T	Return lim.		Return lim.
		Room lim.		
		Parallel priority		
		Flow / power lim.		Flow / power lim.
		Holiday		Holiday
		Ext. override		Ext. override
		ECA override		Anti-bacteria
		Boost		
		Ramp		
		Slave, demand		
		Heating cut-out		
		DHW priority		
		SCADA offset		SCADA offset
		Floor dry., active		

Operating Guide ECL Comfort 210 / 296 / 310, application A266

Navigation, A266.1, Common controller settings

Home MENU Time & Date		Common controller settings	
		ID no.	Function
Holiday		Selectable	
Input overview		Outdoor T Outdoor acc. T Room T Heat flow T DHW flow T Heat return T DHW return T	
Log (sensors)	Outdoor T Room T & desired Heating flow T & des. DHW flow T & des. Heat return T & limit DHW return T & limit	Log today Log yesterday Log 2 days Log 4 days	
Output override		M1 P1 V1 M2 P2 V2 A1	
Floor drying		Functional heating	Desired flow T X1 X2 X3 X4
		Curing heating	Desired flow T X5 X6 X7 X8 Ramp X5–X6 Ramp X7–X8 Max. pwr. failure After power fail. Prog. execution Appl. continue

Operating Guide ECL Comfort 210 / 296 / 310, application A266

Navigation, A266.1, Common controller settings continued

Home MENU		Common controller settings	
		ID no.	Function
Key functions	New application		Erase application
	Application		
	Factory setting		System settings User settings Go to factory
	Copy		To System settings User settings Start copying
	Key overview		
System	ECL version		Code no. Hardware Software Build no. Serial no. Production date
	Extension		
	Ethernet (ECL Comfort 296 and 310 only)		Address type
	Portal config (ECL Comfort 296 and 310 only)		ECL portal Portal status Portal info
	M-bus config (ECL Comfort 296 and 310 only)	5998 Command 5997 Baud 6000 M-bus address 6002 Scan time 6001 Type	
	Energy Meters (ECL Comfort 296 and 310 only)		Energy Meter 1...5
	Raw input overview		S1 - S8 (ECL Comfort 210) S1 - S10 (ECL Comfort 310) S1 - S18 (ECL Comfort 310 with ECA 32)
	Sensor offset		S1...S10 offset
	Alarm		32: T sensor defect
	Display		60058 Backlight 60059 Contrast
	Communication		38 Modbus addr. 2048 ECL 485 addr. 39 Baud 2150 Service pin 2151 Ext. reset
	Language		2050 Language

Operating Guide ECL Comfort 210 / 296 / 310, application A266

Navigation, A266.2, circuit 1 and 2

Home		Circuit 1, Heating		Circuit 2, DHW	
		ID no.	Function	ID no.	Function
MENU					
Schedule		Selectable		Selectable	
Settings	Flow temperature	11178 11177 11004	Heat curve Temp. max. Temp. min. Desired T	12178 12177	Temp. max. Temp. min.
	Room limit	11015 11182 11183	Adapt. time Infl. - max. Infl. - min.		
	Return limit	11031 11032 11033 11034 11035 11036 11037 11085 11029 11028	High T out X1 Low limit Y1 Low T out X2 High limit Y2 Infl. - max. Infl. - min. Adapt. time Priority DHW, ret. T limit Con. T, re. T lim.	12030 12035 12036 12037 12085	Limit Infl. - max. Infl. - min. Adapt. time Priority
	Flow / power limit	11119 11117 11118 11116 11112 11113 11109 11115 11114	Actual Limit High T out X1 Low limit Y1 Low T out X2 High limit Y2 Adapt. time Filter constant Input type Units Pulse	12111 12112 12113 12109 12115 12114	Actual Limit Adapt. time Filter constant Input type Units Pulse
	Optimization	11011 11012 11013 11014 11026 11020 11021 11179 11043	Auto saving Boost Ramp Optimizer Pre-stop Based on Total stop Summer, cut-out Parallel operation		

Operating Guide ECL Comfort 210 / 296 / 310, application A266

Navigation, A266.2, circuit 1 and circuit 2 continued

Home MENU Settings	Control par.	Circuit 1, Heating		Circuit 2, DHW	
		ID no.	Function	ID no.	Function
		11174	Motor pr.	12173	Auto tuning
		11184	Xp	12174	Motor pr.
		11185	Tn		Xp actual
		11186	M run	12185	Tn
		11187	Nz	12186	M run
				12187	Nz
				12097	Supply T (idle)
				12096	Tn (idle)
				12094	Open time
				12095	Close time
		11189	Min. act. time	12189	Min. act. time
		11024	Actuator	12024	Actuator
	Application	11010	ECA addr.		
		11017	Demand offset		
		11050	P demand		
		11500	Send desired T	12500	Send desired T
		11022	P exercise	12022	P exercise
		11023	M exercise	12023	M exercise
		11052	DHW priority		
		11077	P frost T	12077	P frost T
		11078	P heat T	12078	P heat T
		11040	P post-run	12040	P post-run
		11093	Frost pr. T	12093	Frost pr. T
		11141	Ext. input	12141	Ext. input
		11142	Ext. mode	12142	Ext. mode
	Heat cut-out	11393	Sum. start, day		
		11392	Sum. start, month		
		11179	Summer, cut-out		
		11395	Summer, filter		
		11397	Winter start, day		
		11396	Win. start, month		
		11398	Winter, cut-out		
		11399	Winter, filter		
	Anti-bacteria				Day
					Start time
					Duration
					Desired T
Holiday			Selectable		Selectable

Operating Guide ECL Comfort 210 / 296 / 310, application A266

Navigation, A266.2, circuit 1 and circuit 2 continued

Home MENU		Circuit 1, Heating		Circuit 2, DHW	
		ID no.	Function	ID no.	Function
Alarm	Temp. monitoring	11147	Upper difference	12147	Upper difference
		11148	Lower difference	12148	Lower difference
		11149	Delay	12149	Delay
		11150	Lowest temp.	12150	Lowest temp.
	Max. temperature	11079	Max. flow T		
		11080	Delay		
	Alarm overview		Selectable		Selectable
Influence overview	Des. flow T		Return lim.		Return lim.
			Room lim.		
			Parallel priority		
			Flow / power lim.		Flow / power lim.
			Holiday		Holiday
			Ext. override		Ext. override
			ECA override		Anti-bacteria
			Boost		
			Ramp		
			Slave, demand		
			Heating cut-out		
			DHW priority		
	SCADA offset		SCADA offset		
	Floor dry., active				

Operating Guide ECL Comfort 210 / 296 / 310, application A266

Navigation, A266.2, Common controller settings

Home MENU		Common controller settings	
		ID no.	Function
Time & Date		Selectable	
Holiday		Selectable	
Input overview		Outdoor T Outdoor acc. T Room T Heat flow T DHW flow T Return T Supply T Flow switch	
Log (sensors)	Outdoor T Room T & desired Heating flow & des. DHW flow & des. Heat return T & limit DHW return T & limit Supply T	Log today Log yesterday Log 2 days Log 4 days	
Output override		M1 P1 M2 P2 V2 A1	
Floor drying	Functional heating	Desired flow T X1 X2 X3 X4	
	Curing heating	Desired flow T X5 X6 X7 X8 Ramp X5–X6 Ramp X7–X8 Max. pwr. failure After power fail. Prog. execution Appl. continue	

Operating Guide ECL Comfort 210 / 296 / 310, application A266

Navigation, A266.2, Common controller settings continued

Home MENU		Common controller settings	
		ID no.	Function
Key functions	New application		Erase application
	Application		
	Factory setting		System settings User settings Go to factory
	Copy		To System settings User settings Start copying
	Key overview		
System	ECL version		Code no. Hardware Software Build no. Serial no. Production date
	Extension		
	Ethernet (ECL Comfort 296 and 310 only)		Address type
	Portal config (ECL Comfort 296 and 310 only)		ECL portal Portal status Portal info
	M-bus config (ECL Comfort 296 and 310 only)	5998 5997 6000 6002 6001	Command Baud M-bus address Scan time Type
	Energy Meters (ECL Comfort 296 and 310 only)		Energy Meter 1...5
	Raw input overview		S1 - S8 (ECL Comfort 210) S1 - S10 (ECL Comfort 310) S1 - S18 (ECL Comfort 310 with ECA 32)
	Sensor offset		S1...S10 offset
	Alarm		32: T sensor defect
	Display		60058 Backlight 60059 Contrast
	Communication		38 Modbus addr. 2048 ECL 485 addr. 39 Baud 2150 Service pin 2151 Ext. reset
	Language		2050 Language

Operating Guide ECL Comfort 210 / 296 / 310, application A266

Navigation, A266.9, circuit 1 and 2

Home		Circuit 1, Heating		Circuit 2, DHW	
		ID no.	Function	ID no.	Function
MENU					
Schedule		Selectable		Selectable	
Settings	Flow temperature		Heat curve		
		11178	Temp. max.	12178	Temp. max.
		11177	Temp. min.	12177	Temp. min.
		11004	Desired T		
	Return limit			12030	Limit
		11031	High T out X1		
		11032	Low limit Y1		
		11033	Low T out X2		
		11034	High limit Y2		
		11035	Infl. - max.	12035	Infl. - max.
		11036	Infl. - min.	12036	Infl. - min.
		11037	Adapt. time	12037	Adapt. time
		11085	Priority		
		11029	DHW, ret. T limit		
		11028	Con. T, re. T lim.		
	Flow / power limit		Actual		Actual
			Limit	12111	Limit
		11119	High T out X1		
		11117	Low limit Y1		
		11118	Low T out X2		
		11116	High limit Y2		
		11112	Adapt. time	12112	Adapt. time
		11113	Filter constant	12113	Filter constant
		11109	Input type	12109	Input type
		11115	Units	12115	Units
	Optimization	11011	Auto saving		
		11012	Boost		
		11013	Ramp		
		11014	Optimizer		
		11026	Pre-stop		
		11021	Total stop		
		11179	Summer, cut-out		
		11043	Parallel operation		

Operating Guide ECL Comfort 210 / 296 / 310, application A266

Navigation, A266.9, circuit 1 and circuit 2 continued

Home MENU		Circuit 1, Heating		Circuit 2, DHW		
		ID no.	Function	ID no.	Function	
Settings	Control par.			12173	Auto tuning	
		11174	Motor pr.	12174	Motor pr.	
		11184	Xp	12184	Xp	
		11185	Tn	12185	Tn	
		11186	M run	12186	M run	
		11187	Nz	12187	Nz	
		11189	Min. act. time	12189	Min. act. time	
		11024	Actuator	12024	Actuator	
	Application		11017	Demand offset		
			11050	P demand		
		11500	Send desired T	12500	Send desired T	
		11022	P exercise	12022	P exercise	
		11023	M exercise	12023	M exercise	
		11052	DHW priority			
		11077	P frost T	12077	P frost T	
		11078	P heat T	12078	P heat T	
		11040	P post-run	12040	P post-run	
		11093	Frost pr. T	12093	Frost pr. T	
		11141	Ext. input	12141	Ext. input	
		11142	Ext. mode	12142	Ext. mode	
Heat cut-out		11393	Sum. start, day			
		11392	Sum. start, month			
		11179	Summer, cut-out			
		11395	Summer, filter			
		11397	Winter start, day			
		11396	Win. start, month			
		11398	Winter, cut-out			
		11399	Winter, filter			
Anti-bacteria				Day		
				Start time		
				Duration		
				Desired T		
Alarm	Pressure	11614	Alarm high			
		11615	Alarm low			
		11617	Alarm time-out			
		11607	Low X			
		11608	High X			
		11609	Low Y			
	Digital	11636	Alarm value			
		11637	Alarm time-out			
	Max. temperature	11079	Max. flow T			
		11080	Delay			
Alarm overview		Selectable				

Operating Guide ECL Comfort 210 / 296 / 310, application A266

Navigation, A266.9, circuit 1 and circuit 2 continued

Home MENU	Circuit 1, Heating		Circuit 2, DHW	
	ID no.	Function	ID no.	Function
Influence overview		Return lim.		Return lim.
Des. flow T		Parallel priority		Flow / power limit
		Flow / power limit		Ext. override
		Ext. override		Anti-bacteria
		Boost		
		Ramp		
		Slave, demand		
		Heating cut-out		
		DHW priority		
		SCADA offset		SCADA offset
		Floor dry., active		

Operating Guide ECL Comfort 210 / 296 / 310, application A266

Navigation, A266.9, Common controller settings

Home MENU Time & Date		Common controller settings	
		ID no.	Function
Input overview			Selectable
Input overview			Outdoor T Outdoor acc. T Heat return T Heat flow T DHW flow T Prim. return T DHW return T Pressure Digital
Log (sensors)	Heating flow & des. Heating return DHW flow & des. DHW return Outdoor T Heating pressure		Log today Log yesterday Log 2 days Log 4 days
Output override			M1 P1 M2 V1 P2 V2 A1
Floor drying	Functional heating		Desired flow T X1 X2 X3 X4
	Curing heating		Desired flow T X5 X6 X7 X8 Ramp X5–X6 Ramp X7–X8 Max. pwr. failure After power fail. Prog. execution Appl. continue

Operating Guide ECL Comfort 210 / 296 / 310, application A266

Navigation, A266.9, Common controller settings continued

Home MENU		Common controller settings		
		ID no.	Function	
Key functions	New application		Erase application	
	Application			
	Factory setting		System settings User settings Go to factory	
	Copy		To System settings User settings Start copying	
	Key overview			
System	ECL version		Code no. Hardware Software Build no. Serial no. Production date	
	Extension			
	Ethernet (ECL Comfort 296 and 310 only)		Address type	
	Portal config (ECL Comfort 296 and 310 only)		ECL portal Portal status Portal info	
	M-bus config (ECL Comfort 296 and 310 only)	5998 Command 5997 Baud 6000 M-bus address 6002 Scan time 6001 Type		
	Energy Meters (ECL Comfort 296 and 310 only)		Energy Meter 1...5	
	Raw input overview		S1 - S8 (ECL Comfort 210) S1 - S10 (ECL Comfort 310) S1 - S18 (ECL Comfort 310 with ECA 32)	
	Sensor offset		S1...S10 offset	
	Alarm		32: T sensor defect	
	Display		60058 Backlight 60059 Contrast	
	Communication		38 Modbus addr. 2048 ECL 485 addr. 39 Baud 2150 Service pin 2151 Ext. reset	
	Language		2050 Language	

Operating Guide ECL Comfort 210 / 296 / 310, application A266

Navigation, A266.10, circuit 1 and 2

Home		Circuit 1, Heating		Circuit 2, DHW	
		ID no.	Function	ID no.	Function
MENU					
Schedule			Selectable		Selectable
Settings	Flow temperature		Heat curve		
		11178	Temp. max.	12178	Temp. max.
		11177	Temp. min.	12177	Temp. min.
		11004	Desired T		
	Return limit			12030	Limit
		11031	High T out X1		
		11032	Low limit Y1		
		11033	Low T out X2		
		11034	High limit Y2		
		11035	Infl. - max.	12035	Infl. - max.
		11036	Infl. - min.	12036	Infl. - min.
		11037	Adapt. time	12037	Adapt. time
		11085	Priority		
		11029	DHW, ret. T limit		
		11028	Con. T, re. T lim.		
	Flow / power limit		Actual		Actual
			Limit	12111	Limit
		11119	High T out X1		
		11117	Low limit Y1		
		11118	Low T out X2		
		11116	High limit Y2		
		11112	Adapt. time	12112	Adapt. time
		11113	Filter constant	12113	Filter constant
		11109	Input type	12109	Input type
		11115	Units	12115	Units
		11114	Pulse	12114	Pulse
	Optimization	11011	Auto saving		
		11012	Boost		
		11013	Ramp		
		11014	Optimizer		
		11026	Pre-stop		
		11021	Total stop		
		11179	Summer, cut-out		
		11043	Parallel operation		

Operating Guide ECL Comfort 210 / 296 / 310, application A266

Navigation, A266.10, circuit 1 and circuit 2 continued

Home MENU	Control par.	Circuit 1, Heating		Circuit 2, DHW			
		ID no.	Function	ID no.	Function		
Settings	Control par.			12173	Auto tuning		
		11174	Motor pr.	12174	Motor pr.		
		11184	Xp	12184	Xp		
		11185	Tn	12185	Tn		
		11186	M run	12186	M run		
		11187	Nz	12187	Nz		
		11189	Min. act. time	12189	Min. act. time		
		11024	Actuator	12024	Actuator		
		Application	Application	11017	Demand offset		
				11050	P demand		
11500	Send desired T			12500	Send desired T		
11022	P exercise			12022	P exercise		
11023	M exercise			12023	M exercise		
11052	DHW priority						
11077	P frost T			12077	P frost T		
11078	P heat T			12078	P heat T		
11040	P post-run			12040	P post-run		
11093	Frost pr. T			12093	Frost pr. T		
11141	Ext. input			12141	Ext. input		
11142	Ext. mode			12142	Ext. mode		
Heat cut-out	Heat cut-out	11393	Sum. start, day				
		11392	Sum. start, month				
		11179	Summer, cut-out				
		11395	Summer, filter				
		11397	Winter start, day				
		11396	Win. start, month				
		11398	Winter, cut-out				
		11399	Winter, filter				
Anti-bacteria	Anti-bacteria			Day			
				Start time			
				Duration			
				Desired T			
Alarm	Digital	11636	Alarm value				
		11637	Alarm time-out				
	Max. temperature	11079	Max. flow T				
		11080	Delay				
Alarm overview	Alarm overview	Selectable					

Operating Guide ECL Comfort 210 / 296 / 310, application A266

Navigation, A266.10, circuit 1 and circuit 2 continued

Home MENU Influence overview Des. flow T	Circuit 1, Heating		Circuit 2, DHW	
	ID no.	Function	ID no.	Function
		Return lim.		Return lim.
		Parallel periority		Flow / power limit
		Flow / power limit		Ext. override
		Ext. override		Anti-bacteria
		Boost		
		Ramp		
		Slave, demand		
		Heating cut-out		
		DHW priority		
		SCADA offset		SCADA offset
		Floor dry., active		

Operating Guide ECL Comfort 210 / 296 / 310, application A266

Navigation, A266.10, Common controller settings

Home MENU Time & Date		Common controller settings	
		ID no.	Function
Input overview			Selectable
Log (sensors)		Heating flow & des. Heating return DHW flow & des. DHW return Outdoor T	Outdoor T Outdoor acc. T Heat return T Heat flow T DHW flow T Prim. return T DHW return T Digital
Output override			Log today Log yesterday Log 2 days Log 4 days
Floor drying		Functional heating	M1 P1 M2 V1 P2 V2 A1
		Curing heating	Desired flow T X1 X2 X3 X4 Desired flow T X5 X6 X7 X8 Ramp X5–X6 Ramp X7–X8 Max. pwr. failure After power fail. Prog. execution Appl. continue

Operating Guide ECL Comfort 210 / 296 / 310, application A266

Navigation, A266.10, Common controller settings continued

Home MENU		Common controller settings	
		ID no.	Function
Key functions	New application		Erase application
	Application		
	Factory setting		System settings User settings Go to factory
	Copy		To System settings User settings Start copying
	Key overview		
System	ECL version		Code no. Hardware Software Build no. Serial no. Production date
	Extension		
	Ethernet (ECL Comfort 296 and 310 only)		Address type
	Portal config (ECL Comfort 296 and 310 only)		ECL portal Portal status Portal info
	M-bus config (ECL Comfort 296 and 310 only)	5998 5997 6000 6002 6001	Command Baud M-bus address Scan time Type
	Energy Meters (ECL Comfort 296 and 310 only)		Energy Meter 1...5
	Raw input overview		S1 - S8 (ECL Comfort 210) S1 - S10 (ECL Comfort 310) S1 - S18 (ECL Comfort 310 with ECA 32)
	Sensor offset		S1...S10 offset
	Alarm		32: T sensor defect
	Display		60058 Backlight 60059 Contrast
	Communication		38 Modbus addr. 2048 ECL 485 addr. 39 Baud 2150 Service pin 2151 Ext. reset
	Language		2050 Language

Operating Guide ECL Comfort 210 / 296 / 310, application A266

3.0 Daily use

3.1 How to navigate

You navigate in the controller by turning the dial left or right to the desired position (◂/◃).

The dial has a built-in accelerator. The faster you turn the dial, the faster it reaches the limits of any wide setting range.

The position indicator in the display (▶) will always show you where you are.

Push the dial to confirm your choices (Ⓜ).

The display examples are from a two-circuit application: One heating circuit (▮) and one domestic hot-water (DHW) circuit (⚡). The examples might differ from your application.

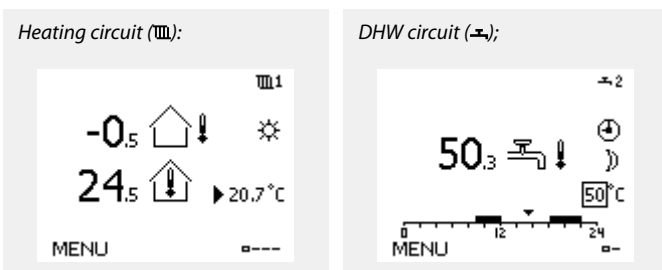
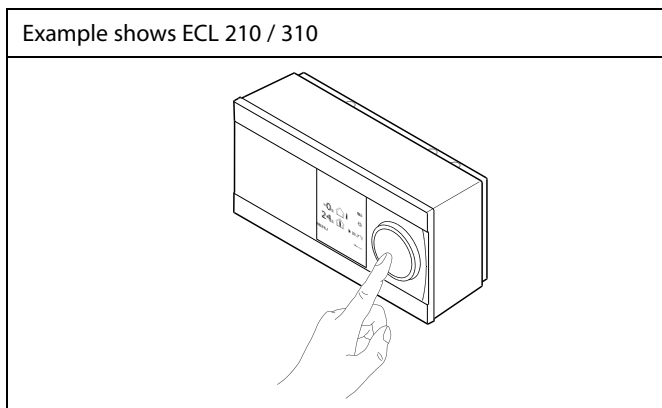

Some general settings which apply to the entire controller are located in a specific part of the controller.

To enter 'Common controller settings':

Action:	Purpose:	Examples:
	Choose 'MENU' in any circuit	MENU
	Confirm	
	Choose the circuit selector at the top right corner in the display	
	Confirm	
	Choose 'Common controller settings'	▮▮
	Confirm	

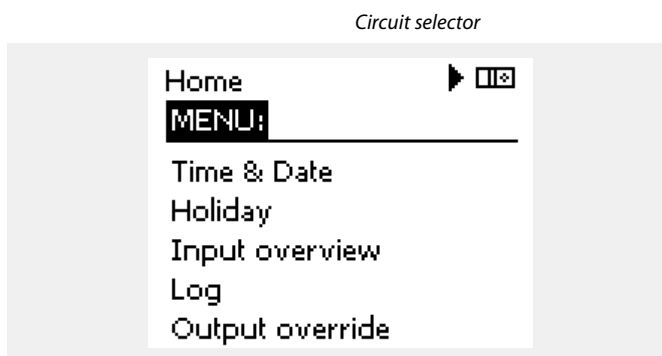

Operating Guide ECL Comfort 210 / 296 / 310, application A266

3.2 Understanding the controller display

This section describes the function in general for the ECL Comfort 210 / 296 / 310 series. The shown displays are typical and not application related. They might differ from the displays in your application.

Choosing a favorite display

Your favorite display is the display you have chosen as the default display. The favorite display will give you a quick overview of the temperatures or units that you want to monitor in general.

If the dial has not been activated for 20 min., the controller will revert to the overview display you have chosen as favorite.



To shift between displays: Turn the dial until you reach the display selector (=---) at the bottom right side of the display. Push the dial and turn to choose your favorite overview display. Push the dial again.

Heating circuit

Overview display 1 informs about:
actual outdoor temperature, controller mode,
actual room temperature, desired room temperature.

Overview display 2 informs about:
actual outdoor temperature, trend in outdoor temperature,
controller mode, max. and min. outdoor temperatures since
midnight as well as desired room temperature.

Overview display 3 informs about:
date, actual outdoor temperature, controller mode, time, desired
room temperature as well as shows the comfort schedule of the
current day.

Overview display 4 informs about:
state of the controlled components, actual flow temperature,
(desired flow temperature), controller mode, return temperature
(limitation value), influence on desired flow temperature.

The value above the V2 symbol indicates 0–100% of the analogue
signal (0–10 V).

Note:

An actual flow temperature value must be present, otherwise the
circuit's control valve will close.

Dependent on the chosen display, the overview displays for the
heating circuit inform you about:

- actual outdoor temperature (-0.5)
- controller mode (☼)
- actual room temperature (24.5)
- desired room temperature (20.7 °C)
- trend in outdoor temperature (↗ → ↘)
- min. and max. outdoor temperatures since midnight (↕)
- date (23.02.2010)
- time (7:43)
- comfort schedule of the current day (0 - 12 - 24)
- state of the controlled components (M2, P2)
- actual flow temperature (49 °C), (desired flow temperature (31))
- return temperature (24 °C) (limitation temperature (50))

Overview display 1:

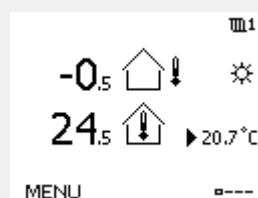

Overview display 2:



Overview display 3:

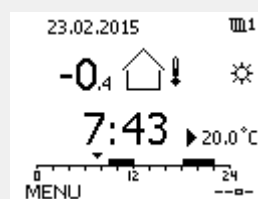

Overview display 4:

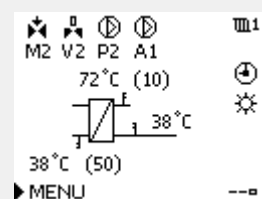

Example of overview display with
Influence indication:

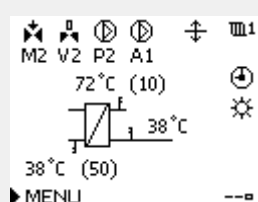

Example, favorite display 1 in
A230.3, where min. desired room
temperature is indicated (22.7):

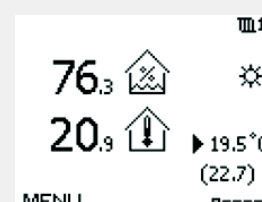



The setting of the desired room temperature is important even if a room temperature sensor / Remote Control Unit is not connected.



If the temperature value is displayed as

"- -" the sensor in question is not connected.

"- - -" the sensor connection is short-circuited.

DHW circuit

Overview display 1 informs about: actual DHW temperature, controller mode, desired DHW temperature as well as the comfort schedule of the current day.

Overview display 2 informs about: state of the controlled components, actual DHW temperature, (desired DHW temperature), controller mode, return temperature (limitation value), influence on desired DHW temperature.

Dependent on chosen display, the overview displays for the DHW circuit inform you about:

- actual DHW temperature (50.3)
- controller mode (☼)
- desired DHW temperature (50 °C)
- comfort schedule of the current day(0 - 12 - 24)
- state of the controlled components (M1, P1)
- actual DHW temperature (50 °C), (desired DHW temperature (50))
- return temperature (- - °C) (limitation temperature (30))

Overview display 1:

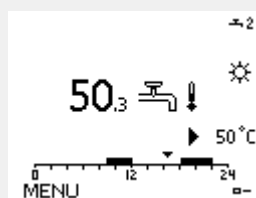

Overview display 2:

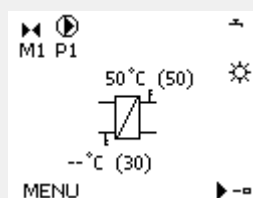

Example of overview display with Influence indication:

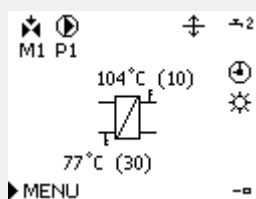

Setting the desired temperature

Depending on the chosen circuit and mode, it is possible to enter all daily settings directly from the overview displays (see also the next page concerning symbols).

Operating Guide ECL Comfort 210 / 296 / 310, application A266

Setting the desired room temperature

The desired room temperature can easily be adjusted in the overview displays for the heating circuit.

Action:	Purpose:	Examples:
	Desired room temperature	20.5
	Confirm	
	Adjust the desired room temperature	21.0
	Confirm	

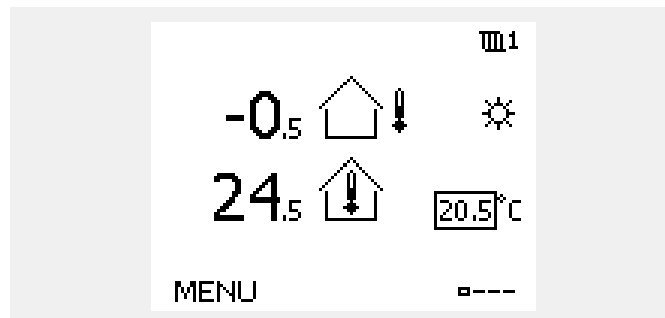

This overview display informs about outdoor temperature, actual room temperature as well as desired room temperature.

The display example is for comfort mode. If you want to change the desired room temperature for saving mode, choose the mode selector and select saving.



The setting of the desired room temperature is important even if a room temperature sensor / Remote Control Unit is not connected.

Setting the desired room temperature, ECA 30 / ECA 31

The desired room temperature can be set exactly as in the controller. However, other symbols can be present in the display (please see 'What do the symbols mean?').



With the ECA 30 / ECA 31 you can override the desired room temperature set in the controller temporarily by means of the override functions:

Operating Guide ECL Comfort 210 / 296 / 310, application A266

Setting the desired DHW temperature

The desired DHW temperature can easily be adjusted in the overview displays for the DHW circuit.

Action:	Purpose:	Examples:
	Desired DHW temperature	50
	Confirm	
	Adjust the desired DHW temperature	55
	Confirm	

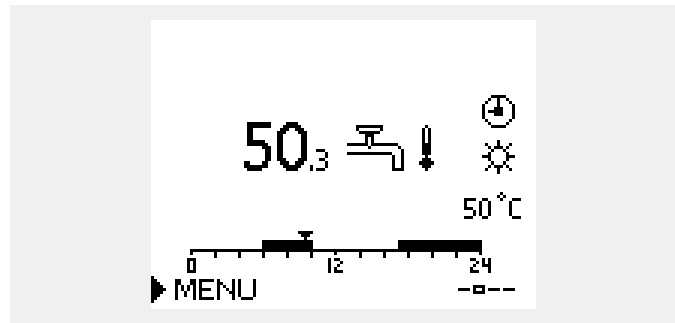

In addition to the information about desired and actual DHW temperature, the today's schedule is visible.

The display example indicates that the controller is in scheduled operation and in comfort mode.

3.3 A general overview: What do the symbols mean?

Symbol	Description	
	Outdoor temp.	Temperature
	Relative humidity indoor	
	Room temp.	
	DHW temp.	
	Position indicator	
	Scheduled mode	Mode
	Comfort mode	
	Saving mode	
	Frost protection mode	
	Manual mode	
	Standby	
	Cooling mode	
	Active output override	
	Optimized start or stop time	
	Heating	Circuit
	Cooling	
	DHW	
	Common controller settings	
	Pump ON	Controlled component
	Pump OFF	
	Fan ON	
	Fan OFF	
	Actuator opens	
	Actuator closes	
	Actuator, analogue control signal	
	Pump / fan speed	
	Damper ON	
	Damper OFF	

Symbol	Description
	Alarm
	Letter
	Event
	Monitoring temperature sensor connection
	Display selector
	Max. and min. value
	Trend in outdoor temperature
	Wind speed sensor
	Sensor not connected or not used
	Sensor connection short-circuited
	Fixed comfort day (holiday)
	Active influence
	Heating active (+) Cooling active (-)
	Number of heat exchangers

Additional symbols, ECA 30 / 31:

Symbol	Description
	ECA Remote Control Unit
	Connection address (master: 15, slaves: 1 - 9)
	Day off
	Holiday
	Relaxing (extended comfort period)
	Going out (extended saving period)

In ECA 30 / 31 only the symbols that are relevant to the application in the controller are displayed.

3.4 Monitoring temperatures and system components

This section describes the function in general for the ECL Comfort 210 / 296 / 310 series. The shown displays are typical and not application related. They might differ from the displays in your application.

Heating circuit

The overview display in the heating circuit ensures a quick overview of the actual and (desired) temperatures as well as the actual state of the system components.

Display example:

49 °C	Flow temperature
(31)	Desired flow temperature
24 °C	Return temperature
(50)	Return temperature limitation

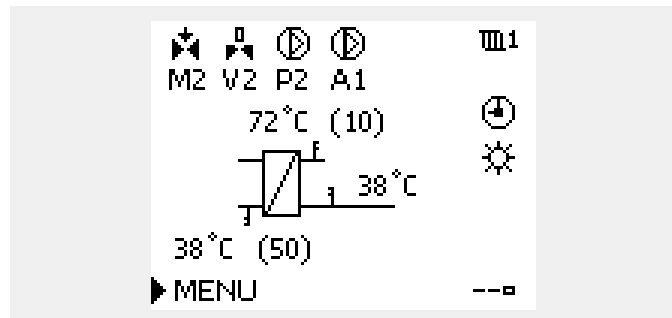

DHW circuit

The overview display in the DHW circuit ensures a quick overview of the actual and (desired) temperatures as well as the actual state of the system components.

Display example (heat exchanger):

50 °C	Flow temperature
(50)	Desired flow temperature
- -	Return temperature: sensor not connected
(30)	Return temperature limitation

Display example with heat exchanger:

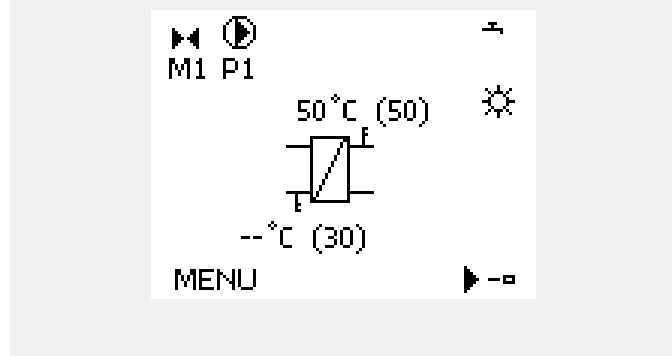

Input overview

Another option to get a quick overview of measured temperatures is the 'Input overview' which is visible in the common controller settings (how to enter the common controller settings, see 'Introduction to common controller settings')

As this overview (see display example) only states the measured actual temperatures, it is read-only.

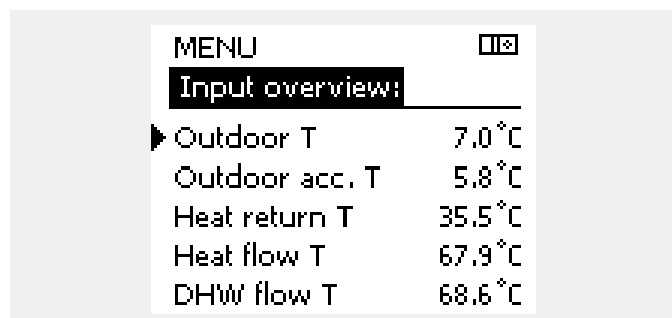

3.5 Influence overview

This section describes the function in general for the ECL Comfort 210 / 296 / 310 series. The shown displays are typical and not application related. They might differ from the displays in your application.

The menu gives an overview of the influences on the desired flow temperature. It differs from application to application which parameters are listed. It can be helpful in a service situation to explain unexpected conditions or temperatures among others.

If the desired flow temperature is influenced (corrected) by one or more parameters, it is indicated by a small line with arrow-down, arrow-up or double-arrow:

Arrow-down:

The parameter in question reduces the desired flow temperature.

Arrow-up:

The parameter in question increases the desired flow temperature.

Double-arrow:

The parameter in question creates an override (e.g. Holiday).

Straight line:

No active influence.

In the example, the arrow in the symbol points downwards for 'Room lim.'. This means that the actual room temperature is higher than the desired room temperature which again results in a decrease of the desired flow temperature.

Example of overview display with Influence indication:

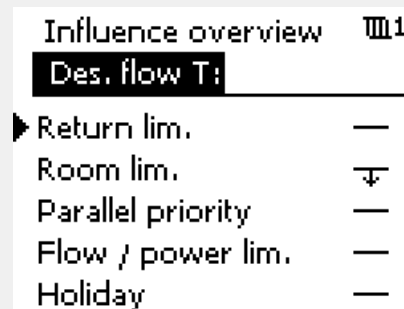
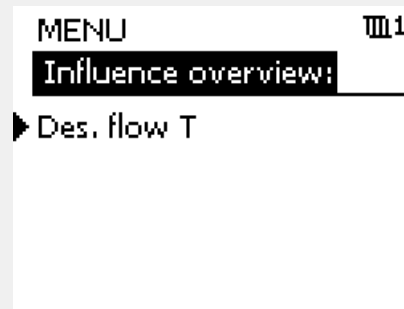
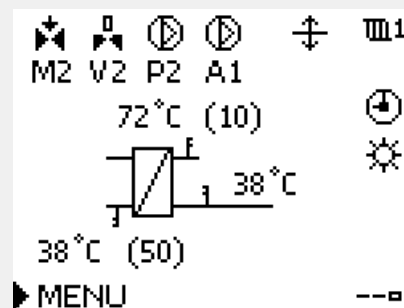

Operating Guide ECL Comfort 210 / 296 / 310, application A266

3.6 Manual control

This section describes the function in general for the ECL Comfort 210 / 296 / 310 series. The shown displays are typical and not application related. They might differ from the displays in your application.

It is possible to manually control the installed components.

Manual control can only be selected in favorite displays in which the symbols for the controlled components (valve, pump etc.) are visible.

Action:	Purpose:	Examples:
	Choose mode selector	
	Confirm	
	Choose manual mode	
	Confirm	
	Choose pump	
	Confirm	
	Switch ON the pump	
	Switch OFF the pump.	
	Confirm pump mode	
	Choose motorized control valve	
	Confirm	
	Open the valve	
	Stop opening the valve	
	Close the valve	
	Stop closing the valve	
	Confirm valve mode	

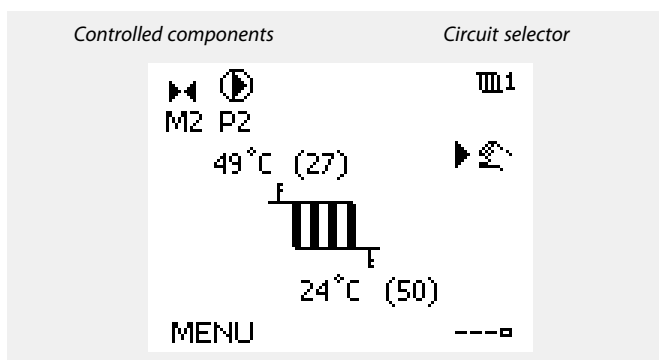

During manual operation:

- All control functions are deactivated
- Output override is not possible
- Frost protection is not active

When manual control is selected for one circuit, it is automatically selected for all circuits!

To leave manual control, use the mode selector to select the desired mode. Push the dial.

Manual control is typically used when commissioning the installation. The controlled components, valve, pump etc., can be controlled for correct function.

Operating Guide ECL Comfort 210 / 296 / 310, application A266

3.7 Schedule

3.7.1 Set your schedule

This section describes the schedule in general for the ECL Comfort 210 / 296 / 310 series. The shown displays are typical and not application related. They might differ from the displays in your application. In some applications, however, there might be more than one schedule. Additional schedules can be found in 'Common controller settings'.

The schedule consists of a 7-day week:

- M = Monday
- T = Tuesday
- W = Wednesday
- T = Thursday
- F = Friday
- S = Saturday
- S = Sunday

The schedule will day-by-day show you the start and stop times of your comfort periods (heating / DHW circuits).

Changing your schedule:

Action:	Purpose:	Examples:
	Choose 'MENU' in any of the overview displays	MENU
	Confirm	
	Confirm the choice 'Schedule'	
	Choose the day to change	▶
	Confirm*	T
	Go to Start1	
	Confirm	
	Adjust the time	
	Confirm	
	Go to Stop1, Start2 etc. etc.	
	Return to 'MENU'	MENU
	Confirm	
	Choose 'Yes' or 'No' in 'Save'	
	Confirm	

* Several days can be marked

The chosen start and stop times will be valid for all the chosen days (in this example Thursday and Saturday).

You can set max. 3 comfort periods a day. You can delete a comfort period by setting start and stop times to the same value.

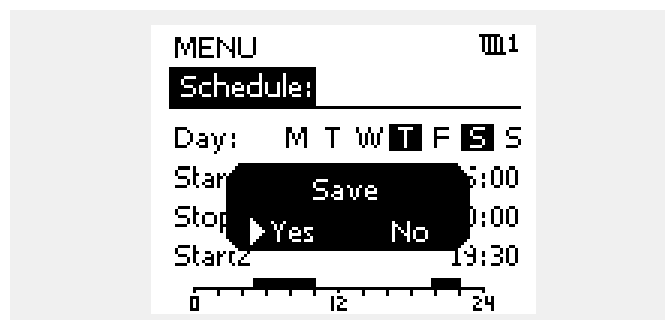
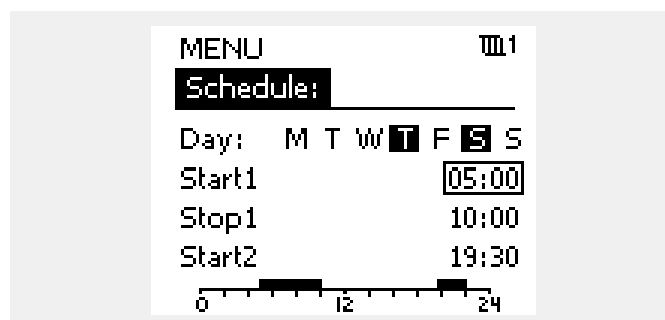
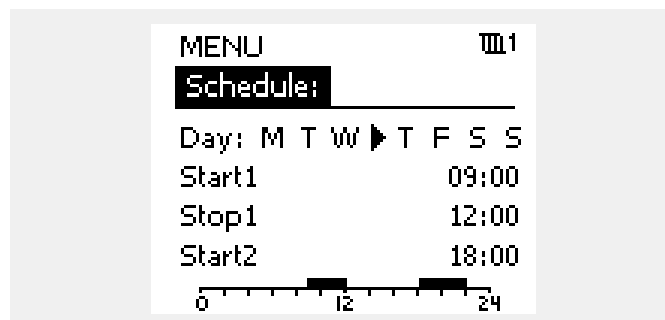

Each circuit has its own schedule. To change to another circuit, go to 'Home', turn the dial and choose the desired circuit.



The start and stop times can be set in half-hourly (30 min.) intervals.

Operating Guide ECL Comfort 210 / 296 / 310, application A266

4.0 Settings overview

For factory settings and setting range, see appendix "Parameter ID overview".

Parameters indicated with an ID no. like "1x607" mean a universal parameter. x stands for circuit / parameter group.

Setting	ID	Page	Factory settings in circuit(s)	
			1	2
Heat curve		72		
Actual (actual flow or power)		84		
Xp actual		98		
Extended heat cut-out setting		111		
Extended winter cut-out setting		111		
Day		120		
Start time		120		
Duration		121		
Desired T		121		
Desired T (Desired flow temperature)	1x004	73		
ECA addr. (ECA address, choice of Remote Control Unit)	1x010	102		
Auto saving (saving temp. dependent on outdoor temp.)	1x011	88		
Boost	1x012	89		
Ramp (reference ramping)	1x013	90		
Optimizer (optimizing time constant)	1x014	90		
Adapt. time (adaption time)	1x015	75		
Demand offset	1x017	102		
Based on (optimization based on room / outdoor temp.)	1x020	91		
Total stop	1x021	91		
P exercise (pump exercise)	1x022	102		
M exercise (valve exercise)	1x023	103		
Actuator	1x024	96		
Pre-stop (optimized stop time)	1x026	92		
Con.T, re. T lim. (Constant temperature mode, return temperature limitation)	1x028	79		
DHW, ret. T limit	1x029	79		
Limit (return temp. limitation)	1x030	80		
High T out X1 (return temp. limitation, high limit, X-axis)	1x031	80		
Low limit Y1 (return temp. limitation, low limit, Y-axis)	1x032	80		
Low T out X2 (return temp. limitation, low limit, X-axis)	1x033	80		
High limit Y2 (return temp. limitation, high limit, Y-axis)	1x034	81		
Infl. - max. (return temp. limitation - max. influence)	1x035	81		
Infl. - min. (return temp. limitation - min. influence)	1x036	81		
Adapt. time (adaptation time)	1x037	81		
P post-run	1x040	103		
Parallel operation	1x043	92		
P demand	1x050	103		
DHW priority (closed valve / normal operation)	1x052	104		
P frost T (circulation pump, frost protection temp.)	1x077	104		

Operating Guide ECL Comfort 210 / 296 / 310, application A266

Setting	ID	Page	Factory settings in circuit(s)	
			1	2
P heat T (heat demand)	1x078	104		
Max. flow T (Maximum flow temperature)	1x079	114		
Delay	1x080	114		
Priority (priority for return temp. limitation)	1x085	82		
Frost pr. T (frost protection temp.)	1x093	105		
Open time	1x094	96		
Close time	1x095	97		
Tn (idle)	1x096	97		
Supply T (idle)	1x097	97		
Input type	1x109	84		
Limit (limitation value)	1x111	84		
Adapt. time (adaptation time)	1x112	84		
Filter constant	1x113	85		
Pulse	1x114	85		
Units	1x115	85		
High limit Y2 (flow / power limitation, high limit, Y-axis)	1x116	86		
Low limit Y1 (flow / power limitation, low limit, Y-axis)	1x117	86		
Low T out X2 (flow / power limitation, low limit, X-axis)	1x118	86		
High T out X1 (flow / power limitation, high limit, X-axis)	1x119	87		
Ext. input (external override)	1x141	105		
Ext. mode (external override mode)	1x142	106		
Upper difference	1x147	114		
Lower difference	1x148	115		
Delay, example	1x149	115		
Lowest temp.	1x150	116		
Auto tuning	1x173	97		
Motor pr. (motor protection)	1x174	98		
Temp. min.	1x177	74		
Temp. max.	1x178	74		
Summer, cut-out (limit for heating cut-out)	1x179	93		
Infl. - max. (room temp. limitation, max.)	1x182	75		
Infl. - min. (room temp. limitation, min.)	1x183	76		
Xp (proportional band)	1x184	98		
Tn (integration time constant)	1x185	99		
M run (running time of the motorized control valve)	1x186	99		
Nz (neutral zone)	1x187	99		
Min. act. time (min. activation time gear motor)	1x189	99		
Send desired T	1x500	108		
Low X	1x607	116		
High X	1x608	116		
Low Y	1x609	116		
High Y	1x610	117		

Operating Guide ECL Comfort 210 / 296 / 310, application A266

Setting	ID	Page	Factory settings in circuit(s)	
			1	2
Alarm high	1x614	117		
Alarm low	1x615	117		
Alarm time-out	1x617	117		
Alarm value	1x636	117		
Alarm time-out	1x637	118		

5.0 Settings

5.1 Introduction to Settings

Descriptions of settings (parameter's functions) are divided into groups as used in the ECL Comfort 210 / 296 / 310 controller's menu structure. Examples: "Flow temperature", "Room limit" and so on. Each group starts with a general explanation.

The descriptions of each parameter are in numeric order, related to the parameter's ID numbers. You might come across differences between the order in this Operating Guide and the ECL Comfort 210 / 296 / 310 controllers.

Some parameter descriptions are related to specific application subtypes. This means that you might not see the related parameter in the actual subtype in the ECL controller.

The note "See Appendix ..." refers to the Appendix at the end of this Operating Guide, where parameter's setting ranges and factory settings are listed.

The navigation hints (for example MENU > Settings > Return limit ...) cover multiple subtypes.

5.2 Flow temperature

The ECL Comfort controller determines and controls the flow temperature related to the outdoor temperature. This relationship is called the heat curve.

The heat curve is set by means of 6 coordinate points. The desired flow temperature is set at 6 pre-defined outdoor temperature values.

The shown value for the heat curve is an average value (slope), based on the actual settings.

Outdoor temp.	Desired flow temp.			Your settings
	A	B	C	
-30 °C	45 °C	75 °C	95 °C	
-15 °C	40 °C	60 °C	90 °C	
-5 °C	35 °C	50 °C	80 °C	
0 °C	32 °C	45 °C	70 °C	
5 °C	30 °C	40 °C	60 °C	
15 °C	25 °C	28 °C	35 °C	

A: Example for floor heating

B: Factory settings

C: Example for radiator heating (high demand)

MENU > Settings > Flow temperature

Heat curve		
1	0.1 ... 4.0	1.0

The heat curve can be changed in two ways:

- The value of the slope is changed (see heat curve examples on next page)
- The coordinates of the heat curve are changed

Change the value of the slope:

Push the dial to enter / change the slope value of the heat curve (example: 1.0).

When the slope of the heat curve is changed by means of the slope value, the common point for all heat curves will be a desired flow temperature = 24.6 °C at an outdoor temperature = 20 °C and a desired room temperature = 20.0 °C.

Change the coordinates:

Push the dial to enter / change the coordinates of the heat curve (example: -30,75).

The heat curve represents the desired flow temperatures at different outdoor temperatures and at a desired room temperature of 20 °C.

If the desired room temperature is changed, the desired flow temperature also changes:

$$(\text{Desired room T} - 20) \times \text{HC} \times 2.5$$

where "HC" is the Heat Curve slope and "2.5" is a constant.

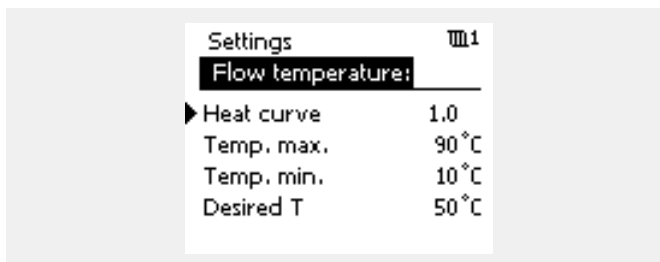
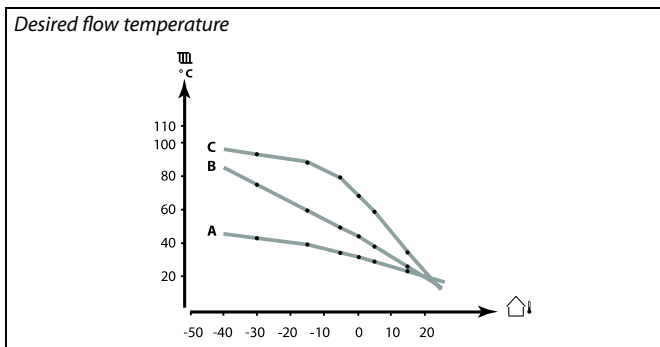

Slope changes

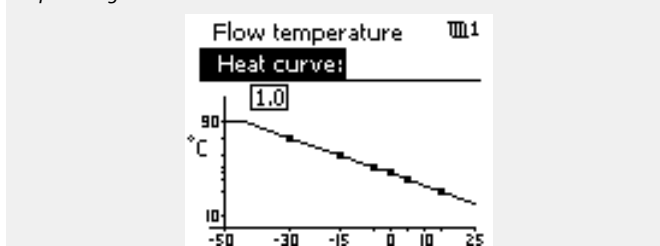

Coordinate changes

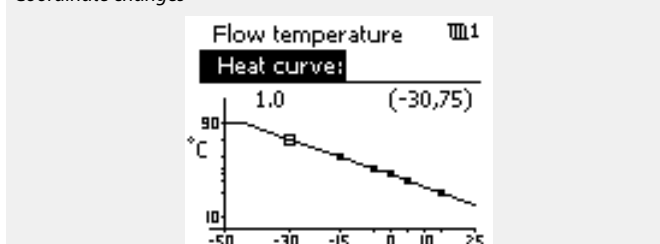

The calculated flow temperature can be influenced by the 'Boost' and 'Ramp' functions etc.

Example:

Heat curve: 1.0
 Desired flow temp.: 50 °C
 Desired room temp.: 22 °C
 Calculation $(22 - 20) \times 1.0 \times 2.5 = 5$

Result:
 The desired flow temperature will be corrected from 50 °C to 55 °C.

Operating Guide ECL Comfort 210 / 296 / 310, application A266

Choosing a heat curve slope

The heat curves represent the desired flow temperature at different outdoor temperatures and at a desired room temperature of 20 °C.

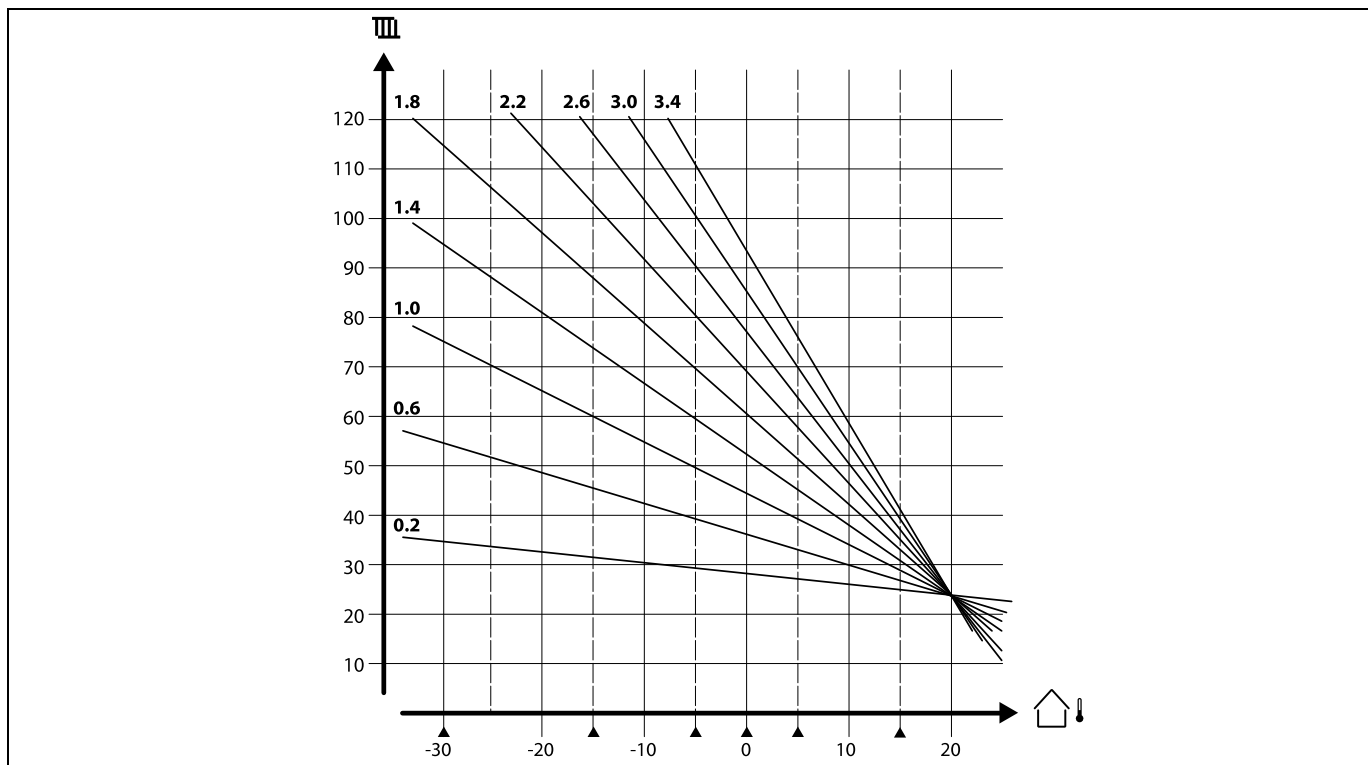

The small arrows (▲) indicate 6 different outdoor temperature values at which you can change the heat curve.

The ECL Comfort 210 / 296 / 310 controls the DHW temperature according to the desired flow temperature for example under the influence of the return temperature. The desired DHW temperature is set in the overview display.

- 50.3: Actual DHW temperature
- 50: Desired DHW temperature

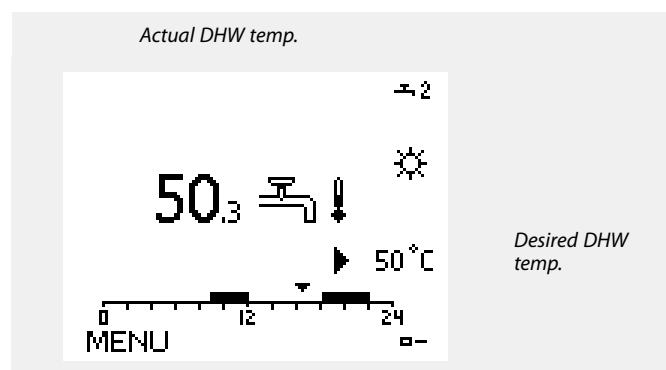

Parameters indicated with an ID no. like "1x607" mean a universal parameter.
x stands for circuit / parameter group.

MENU > Settings > Flow temperature

Desired T (Desired flow temperature)	1x004
<p>When the ECL Comfort is in override mode, type "Const. T", the desired flow temperature can be set. A "Const. T" related return temperature limitation can also be set. See MENU > Settings > Return limit > 'Con. T, ret. T lim.'</p>	

See Appendix "Parameter ID overview"



Override mode
 When ECL Comfort is in Scheduled mode, a contact (switch) signal can be applied to an input in order to override to Comfort, Saving, Frost Protection or Constant temperature. As long as the contact (switch) signal is applied, the override is active.



The "Desired T" value can be influenced by:

- temp. max.
- temp. min.
- room temp. limit
- return temp. limit
- flow / power limit

MENU > Settings > Flow temperature

Temp. min.	1x177
-------------------	--------------

See Appendix "Parameter ID overview"

Set the min. flow temperature for the system. The desired flow temperature will not be lower than this setting. Adjust the factory setting, if required.



'Temp. min.' is overruled if 'Total stop' is active in Saving mode or 'Cut-out' is active.
 'Temp. min.' can be overruled by the influence from the return temperature limitation (see 'Priority').



The setting for 'Temp. max.' has higher priority than 'Temp. min.'

MENU > Settings > Flow temperature

Temp. max.	1x178
-------------------	--------------

See Appendix "Parameter ID overview"

Set the max. flow temperature for the system. The desired temperature will not be higher than this setting. Adjust the factory setting, if required.



The setting of 'heat curve' is possible for heating circuits only.



The setting for 'Temp. max.' has higher priority than 'Temp. min.'

Operating Guide ECL Comfort 210 / 296 / 310, application A266

5.3 Room limit

The following section is a general description for Room temperature limitation.
The actual application might not have both limitation types.

This section is only relevant if you have installed a room temperature sensor or a Remote Control Unit for utilizing the room temperature signal.

In the following description is referred to "flow temperature" in general.

The controller adjusts the desired flow temperature to compensate for the difference between the desired and the actual room temperature.

If the room temperature is higher than the desired value, the desired flow temperature can be reduced.

The 'Infl. -max.' (Influence, max. room temp.) determines how much the desired flow temperature should be reduced.

Use this influence type to avoid a too high room temperature. The controller will allow for free heat gains, i.e. solar radiation or heat from a fire place etc.

If the room temperature is lower than the desired value, the desired flow temperature can be increased.

The 'Infl. -min.' (Influence, min. room temperature) determines how much the desired flow temperature should be increased.

Use this influence type to avoid a too low room temperature. This could e.g. be caused by windy surroundings.

A typical setting will be -4.0 for 'Infl. -max.' and 4.0 for 'Infl. -min.'



Parameters indicated with an ID no. like "1x607" mean a universal parameter.
x stands for circuit / parameter group.

MENU > Settings > Room limit

Adapt. time (adaption time)	1x015
<i>Controls how fast the actual room temperature adapts to the desired room temperature (I control).</i>	



The adaptation function can correct the desired room temperature with max. 8 K x heat curve slope value.

See Appendix "Parameter ID overview"

OFF: The control function is not influenced by the 'Adapt. time'.

Minor value: The desired room temperature is adapted quickly.

Major value: The desired room temperature is adapted slowly.

Operating Guide ECL Comfort 210 / 296 / 310, application A266

MENU > Settings > Room limit

Infl. - max. (room temp. limitation, max.) **1x182**

Determines how much the desired flow temperature will be influenced (decreased) if the actual room temperature is higher than the desired room temperature (P control).

See Appendix "Parameter ID overview"

0.0:	No influence
-2.0:	Minor influence
-5.0:	Medium influence
-9.9:	Maximum influence

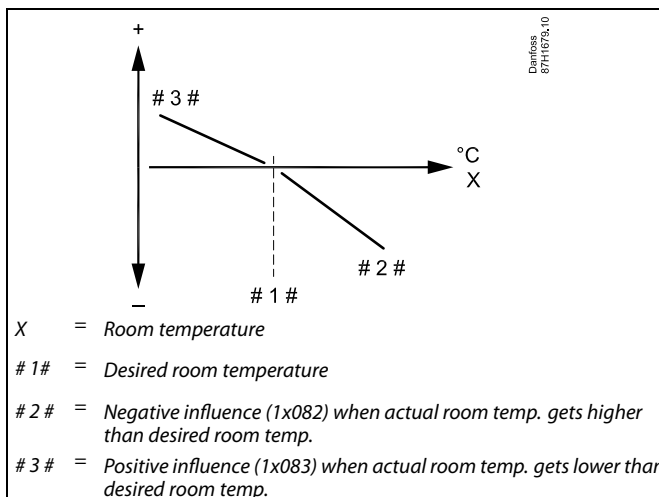

The 'Infl. - max.' and 'Infl. - min.' determine how much the room temperature should influence the desired flow temperature.



If the 'Infl.' factor is too high and / or the 'Adapt. time' too low, there is a risk of unstable control.

Example

The actual room temperature is 2 degrees too high.
The 'Infl. - max.' is set to -4.0.
The heat curve slope is 1.8 (see 'Heat curve' in 'Flow temperature').
Result:
The desired flow temperature is changed by $(2 \times -4.0 \times 1.8)$
-14.4 degrees.

In application subtypes, where a heat curve slope value is **not** present, the heat curve slope value is set to 1:

Result:
The desired flow temperature is changed by $(2 \times -4.0 \times 1)$
-8.0 degrees.

MENU > Settings > Room limit

Infl. - min. (room temp. limitation, min.) **1x183**

Determines how much the desired flow temperature will be influenced (increased) if the actual room temperature is lower than the desired room temperature (P control).

See Appendix "Parameter ID overview"

9.9:	Maximum influence
5.0:	Medium influence
2.0:	Minor influence
0.0:	No influence

Example

The actual room temperature is 2 degrees too low.
The 'Infl. - min.' is set to 4.0.
The heat curve slope is 1.8 (see 'Heat curve' in 'Flow temperature').
Result:
The desired flow temperature is changed by $(2 \times 4.0 \times 1.8)$
14.4 degrees.

In application subtypes, where a heat curve slope value is **not** present, the heat curve slope value is set to 1:

Result:
The desired flow temperature is changed by $(2 \times 4.0 \times 1)$
8.0 degrees.

5.4 Return limit

The return temperature limitation is based on the outdoor temperature. Typically in district heating systems a higher return temperature is accepted at a decrease in outdoor temperature. The relationship between the return temperature limits and outdoor temperature is set in two coordinates.

The outdoor temperature coordinates are set in 'High T out X1' and 'Low T out X2'. The return temperature coordinates are set in 'High limit Y2' and 'Low limit Y1'.

The controller automatically changes the desired flow temperature to obtain an acceptable return temperature when the return temperature falls below or gets higher than the calculated limit. This limitation is based on a PI regulation where P ('Infl.' factor) responds quickly to deviations and I ('Adapt. time') responds slower and over time removes the small offsets between the desired and actual values. This is done by changing the desired flow temperature.

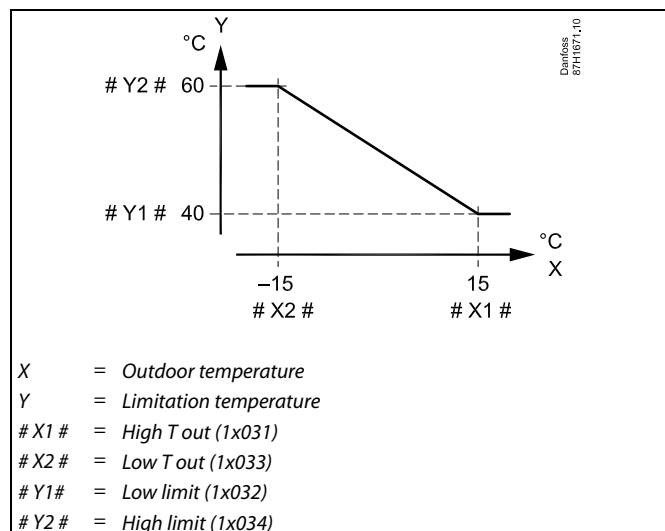

The calculated limit is shown in brackets () in the monitoring display. See the section "Monitoring temperatures and system components".

DHW circuit

The return temperature limitation is based on a constant temperature value.

The controller automatically changes the desired flow temperature to obtain an acceptable return temperature when the return temperature falls below or gets higher than the set limit.

This limitation is based on a PI regulation where P ('Infl.' factor) responds quickly to deviations and I ('Adapt. time') responds slower and over time removes the small offsets between the desired and actual values. This is done by changing the desired flow temperature.

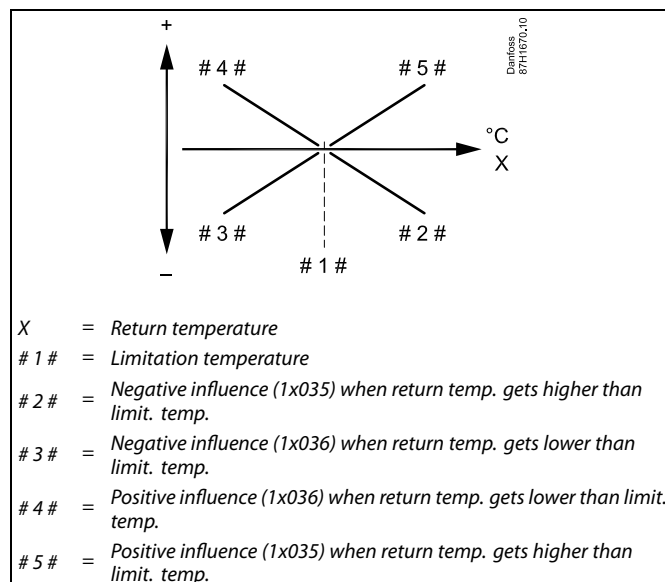

If the 'Infl.' factor is too high and / or the 'Adapt. time' too low, there is a risk of unstable control.

Operating Guide ECL Comfort 210 / 296 / 310, application A266

Example, maximum return temperature limitation;
return temperature gets higher than limit

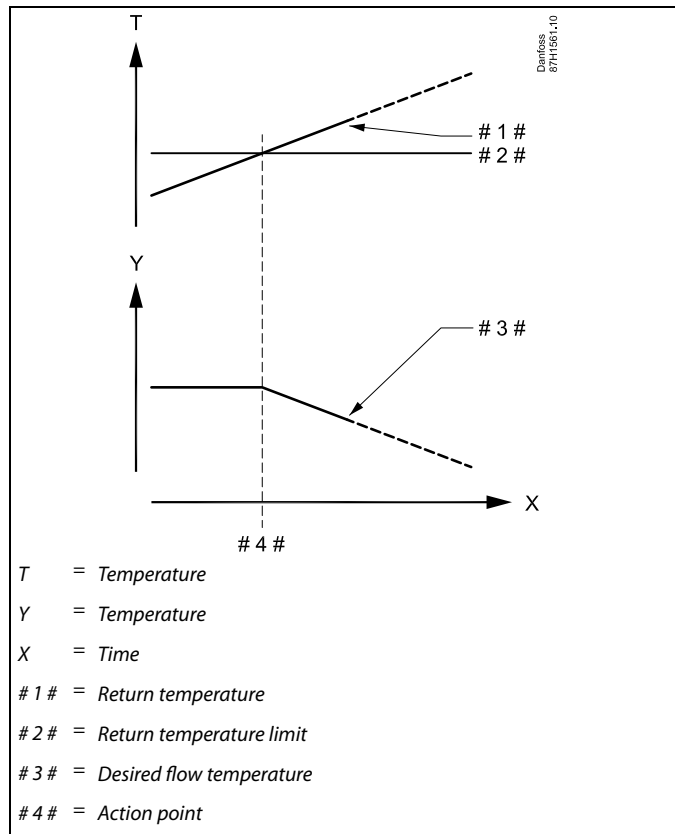

Operating Guide ECL Comfort 210 / 296 / 310, application A266

Example, minimum return temperature limitation;
return temperature gets lower than limit

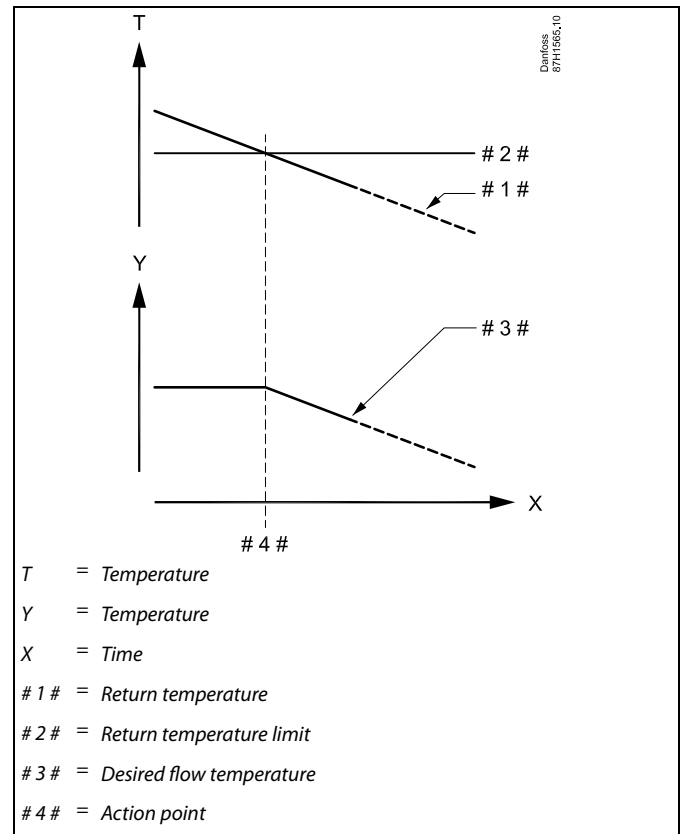

Parameters indicated with an ID no. like "1x607" mean a universal parameter.
x stands for circuit / parameter group.

MENU > Settings > Return limit

Con.T, re. T lim. (Constant temperature mode, return temperature limitation)	1x028
---	--------------

The "Con. T, ret. T limit" is the return temperature limitation value when the circuit is set to override mode type "Const. T" (= Constant temperature).

See Appendix "Parameter ID overview"

Value: Set the return temperature limitation



Override mode

When ECL Comfort is in Scheduled mode, a contact (switch) signal can be applied to an input in order to override to Comfort, Saving, Frost Protection or Constant temperature. As long as the contact (switch) signal is applied, the override is active.

Operating Guide ECL Comfort 210 / 296 / 310, application A266

MENU > Settings > Return limit

DHW, ret. T limit 1x029

When an addressed slave is active in DHW-tank heating / charging, the return temperature limitation in the master can be set.

Notes:

- The master circuit must be set to react on the desired flow temperature in the slave(s). See "Demand offset" (ID 11017).
- The slave(s) must be set to send its / their desired flow temperature to the master. See "Send desired T" (ID 1x500).

See Appendix "Parameter ID overview"

OFF: No influence from slaves. The return temperature limitation is related to settings in "Return limit".

Value: Return temperature limitation value when slave is in DHW tank heating / charging operation.

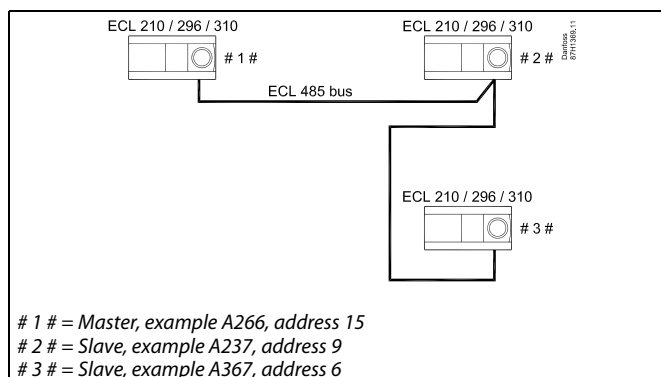

Some examples of applications with DHW-tank heating / charging are:

- A217, A237, A247, A367, A377

MENU > Settings > Return limit

Limit (return temp. limitation) 1x030

Set the return temperature value you accept for the system.

See Appendix "Parameter ID overview"

When the return temperature falls below or gets higher than the set value, the controller automatically changes the desired flow / duct temperature to obtain an acceptable return temperature. The influence is set in 'Infl. - max.' and 'Infl. - min.'.

MENU > Settings > Return limit

High T out X1 (return temp. limitation, high limit, X-axis) 1x031

Set the outdoor temperature value for the low return temperature limitation.

See Appendix "Parameter ID overview"

The corresponding Y coordinate is set in 'Low limit Y1'.

MENU > Settings > Return limit

Low limit Y1 (return temp. limitation, low limit, Y-axis) 1x032

Set the return temperature limitation referring to the outdoor temperature value set in 'High T out X1'.

See Appendix "Parameter ID overview"

The corresponding X coordinate is set in 'High T out X1'.

Operating Guide ECL Comfort 210 / 296 / 310, application A266

MENU > Settings > Return limit

Low T out X2 (return temp. limitation, low limit, X-axis)	1x033
<i>Set the outdoor temperature value for the high return temperature limitation.</i>	

See Appendix "Parameter ID overview"

The corresponding Y coordinate is set in 'High limit Y2'.

MENU > Settings > Return limit

High limit Y2 (return temp. limitation, high limit, Y-axis)	1x034
<i>Set the return temperature limitation referring to the outdoor temperature value set in 'Low T out X2'.</i>	

See Appendix "Parameter ID overview"

The corresponding X coordinate is set in 'Low T out X2'.

MENU > Settings > Return limit

Infl. - max. (return temp. limitation - max. influence)	1x035
<i>Determines how much the desired flow temperature will be influenced if the return temperature is higher than the set limit.</i>	

See Appendix "Parameter ID overview"

Influence higher than 0:

The desired flow temperature is increased, when the return temperature gets higher than the set limit.

Influence lower than 0:

The desired flow temperature is decreased, when the return temperature gets higher than the set limit.

Example

The return limit is active above 50 °C.

The influence is set to 0.5.

The actual return temperature is 2 degrees too high.

Result:

The desired flow temperature is changed by $0.5 \times 2 = 1.0$ degree.

MENU > Settings > Return limit

Infl. - min. (return temp. limitation - min. influence)	1x036
<i>Determines how much the desired flow temperature will be influenced if the return temperature is lower than the calculated limit.</i>	

See Appendix "Parameter ID overview"

Influence higher than 0:

The desired flow temperature is increased, when the return temperature gets below the calculated limit.

Influence lower than 0:

The desired flow temperature is decreased, when the return temperature gets below the calculated limit.

Example

The return limit is active below 50 °C.

The influence is set to -3.0.

The actual return temperature is 2 degrees too low.

Result:

The desired flow temperature is changed by $-3.0 \times 2 = -6.0$ degrees.



Normally, this setting is 0 in district heating systems because a lower return temperature is acceptable.

Typically, this setting is higher than 0 in boiler systems to avoid a too low return temperature (see also 'Infl. - max!').

Operating Guide ECL Comfort 210 / 296 / 310, application A266

MENU > Settings > Return limit

Adapt. time (adaptation time)	1x037
<i>Controls how fast the return temperature adapts to the desired return temperature limit (Integration control).</i>	



The adaptation function can correct the desired flow temperature with max. 8 K.

See Appendix "Parameter ID overview"

OFF: The control function is not influenced by the 'Adapt. time'.

Minor value: The desired temperature is adapted quickly.

Major value: The desired temperature is adapted slowly.

MENU > Settings > Return limit

Priority (priority for return temp. limitation)	1x085
<i>Choose whether the return temperature limitation should overrule the set min. flow temperature 'Temp. min.'.</i>	



If you have a DHW application:
Please also see 'Parallel operation' (ID 11043).

See Appendix "Parameter ID overview"

OFF: The min. flow temperature limit is not overruled.

ON: The min. flow temperature limit is overruled.



If you have a DHW application:
When dependent parallel operation is in function:

- Desired flow temperature for the heating circuit will be minimum limited, when "Priority for return temperature" (ID 1x085) is set to OFF.
- Desired flow temperature for the heating circuit will not be minimum limited, when "Priority for return temperature" (ID 1x085) is set to ON.

Operating Guide ECL Comfort 210 / 296 / 310, application A266

5.5 Flow / power limit

A flow or energy meter can be connected (M-bus signal) to the ECL controller in order to limit the flow or consumed power.

The flow / power limitation can be based on the outdoor temperature. Typically, in district heating systems a higher flow or power is accepted at lower outdoor temperatures.

The relationship between the flow or power limits and the outdoor temperature is set in two coordinates.

The outdoor temperature coordinates are set in 'High T out X1' and 'Low T out X2'.

The flow or power coordinates are set in 'Low limit Y1' and 'High limit Y2'. Based on these settings, the controller calculates the limitation value.

When the flow / power gets higher than the calculated limit, the controller gradually reduces the desired flow temperature to obtain an acceptable max. flow or power consumption.

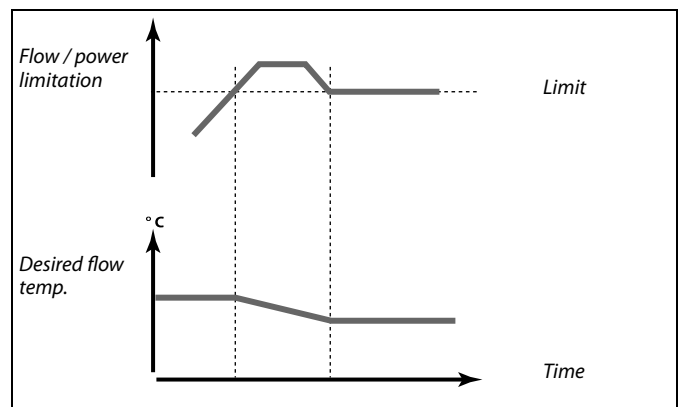
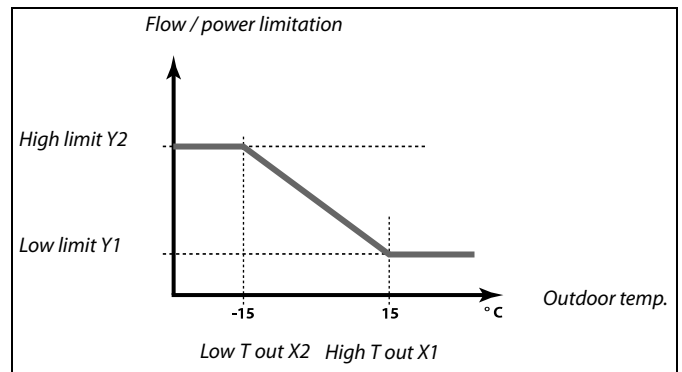

If the 'Adapt. time' is too high, there is a risk of unstable control.

DHW circuit

A flow or heat meter can be connected to the ECL controller in order to limit the flow or consumed power. The signal from the flow or heat meter is a pulse signal.

When the application runs in an ECL Comfort 296 / 310 controller, the flow / power signal can be obtained from a flow / heat meter via the M-bus connection.

When the flow / power gets higher than the calculated limit, the controller gradually reduces the desired flow temperature to obtain an acceptable max. flow or power consumption.

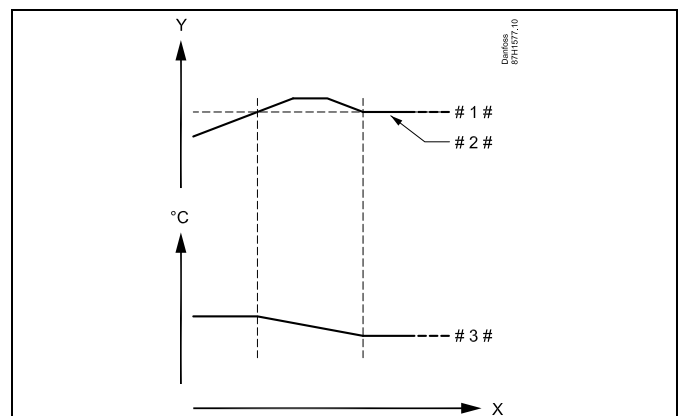

- X = Time
- Y = Flow or power
- # 1 # = Flow or power limit
- # 2 # = Actual flow or energy
- # 3 # = Desired flow temperature

The parameter 'Units' (ID 1x115) has a reduced setting range when the flow / energy signal comes via M-bus.



Pulse based signal for flow / power, applied to input S7

For monitoring:
Frequency range is 0.01 - 200 Hz

For limitation:
Minimum frequency is recommended to be 1 Hz in order to have a stable control. Furthermore, the pulses must appear regularly.



Parameters indicated with an ID no. like "1x607" mean a universal parameter.
x stands for circuit / parameter group.

MENU > Settings > Flow / power limit

Input type	1x109
<i>Choice of input type from flow / energy meter</i>	



The setting range for IM and EM depends on chosen subtype.

See Appendix "Parameter ID overview"

OFF: No input

IM1 - Flow / energy meter signal based on pulses.

IM5:

EM1 - Flow / energy meter signal from M-bus.

EM5:

MENU > Settings > Flow / power limit

Actual (actual flow or power)
<i>The value is the actual flow or power based on the signal from flow / energy meter.</i>

MENU > Settings > Flow / power limit

Limit (limitation value)	1x111
<i>This value is in some applications a calculated limitation value, based on the actual outdoor temperature. In other applications the value is a selectable limitation value.</i>	

See Appendix "Parameter ID overview"

Operating Guide ECL Comfort 210 / 296 / 310, application A266

MENU > Settings > Flow / power limit

Adapt. time (adaptation time)	1x112
<i>Controls how fast the flow / power limitation adapts to the desired limitation.</i>	



If the 'Adapt. time' is too low, there is a risk of unstable control.

See Appendix "Parameter ID overview"

OFF: The control function is not influenced by the 'Adapt. time'.

Minor value: The desired temperature is adapted quickly.

Major value: The desired temperature is adapted slowly.

MENU > Settings > Flow / power limit

Filter constant	1x113
<i>The value of the filter constant determines the dampening of the measured value. The higher the value, the more dampening. By this, a too quick change of the measured value can be avoided.</i>	

See Appendix "Parameter ID overview"

Minor value: Lower dampening

Major value: Higher dampening

MENU > Settings > Flow / power limit

Pulse	1x114
<i>Set the value of the pulses from the flow / energy meter.</i>	

Example :

One pulse can represent a number of litres (from a flow meter) or a number of kWh (from a energy meter).

See Appendix "Parameter ID overview"

OFF: No input.

1 ... 9999: Pulse value.



Pulse based signal for flow / power, applied to input S7

For monitoring:
Frequency range is 0.01 - 200 Hz

For limitation:
Minimum frequency is recommended to be 1 Hz in order to have a stable control. Furthermore, the pulses must appear regularly.

Operating Guide ECL Comfort 210 / 296 / 310, application A266

MENU > Settings > Flow / power limit

Units	1x115
<i>Choice of units for measured values.</i>	

See Appendix "Parameter ID overview"

Units to the left: pulse value.

Units to the right: actual and limitation values.

The value from the flow meter is expressed as ml or l.

The value from the energy meter is expressed as Wh, kWh, MWh or GWh.

The values for the actual flow and the flow limitation are expressed as l/h or m³/h.

The values for the actual power and the power limitation are expressed as kW, MW or GW.



List for setting range of 'Units':

ml, l/h
l, l/h
ml, m³/h
l, m³/h
Wh, kW
kWh, kW
kWh, MW
MWh, MW
MWh, GW
GWh, GW

Example 1:

'Units' (11115): l, m³/h

'Pulse' (11114): 10

Each pulse represents 10 litres and the flow is expressed as cubic meters (m³) per hour.

Example 2:

'Units' (11115): kWh, kW (= kilo Watt hour, kilo Watt)

'Pulse' (11114): 1

Each pulse represents 1 kilo Watt hour and the power is expressed in kilo Watt.

MENU > Settings > Flow / power limit

High limit Y2 (flow / power limitation, high limit, Y-axis)	1x116
<i>Set the flow / power limitation referring to the outdoor temperature set in 'Low T out X2'.</i>	

See Appendix "Parameter ID overview"

The corresponding X coordinate is set in 'Low T out X2'.

MENU > Settings > Flow / power limit

Low limit Y1 (flow / power limitation, low limit, Y-axis)	1x117
<i>Set the flow / power limitation referring to the outdoor temperature set in 'High T out X1'.</i>	

See Appendix "Parameter ID overview"

The corresponding X coordinate is set in 'High T out X1'.



The limitation function can overrule the set 'Temp. min' of the desired flow temperature.

Operating Guide ECL Comfort 210 / 296 / 310, application A266

MENU > Settings > Flow / power limit

Low T out X2 (flow / power limitation, low limit, X-axis)	1x118
<i>Set the outdoor temperature value for the high flow / power limitation.</i>	

See Appendix "Parameter ID overview"

The corresponding Y coordinate is set in 'High limit Y2'.

MENU > Settings > Flow / power limit

High T out X1 (flow / power limitation, high limit, X-axis)	1x119
<i>Set the outdoor temperature value for the low flow / power limitation.</i>	

See Appendix "Parameter ID overview"

The corresponding Y coordinate is set in 'Low limit Y1'.

5.6 Optimization

The section "Optimization" describes specific application related issues.

The parameters 'Auto saving', 'Boost', 'Optimizer', 'Total stop' are all related to heating mode only.

'Summer, cut-out' determine, at rising outdoor temperature, the stop of heating.



Parameters indicated with an ID no. like "1x607" mean a universal parameter.
x stands for circuit / parameter group.

Operating Guide ECL Comfort 210 / 296 / 310, application A266

MENU > Settings > Optimization

Auto saving (saving temp. dependent on outdoor temp.) 1x011

Below the set value for the outdoor temperature, the saving temperature setting has no influence. Above the set value for the outdoor temperature, the saving temperature relates to the actual outdoor temperature. The function is relevant in district heating installations in order to avoid a big change in the desired flow temperature after a saving period.

See Appendix "Parameter ID overview"

OFF: The saving temperature does not depend on the outdoor temperature; the reduction is 100%.

Value: The saving temperature depends on the outdoor temperature. When the outdoor temperature is above 10 °C, the reduction is 100%. The lower the outdoor temperature, the less the temperature reduction. Below the set value, the saving temperature setting has no influence.

Comfort temperature: The desired room temperature in Comfort mode

Saving temperature: The desired room temperature in Saving mode

The desired room temperatures for Comfort and Saving modes are set in the display overviews.

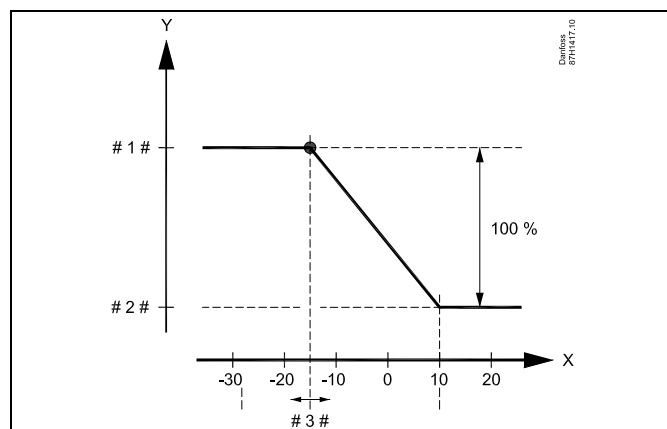

X = Outdoor temperature (°C)
 Y = Desired room temperature (°C)
 # 1 # = Desired room temperature (°C), Comfort mode
 # 2 # = Desired room temperature (°C), Saving mode
 # 3 # = Auto saving temperature (°C), ID 11011

Example:

Actual outdoor temperature (T.out): -5 °C
 Desired room temperature setting in Comfort mode: 22 °C
 Desired room temperature setting in Saving mode: 16 °C
 Setting in 'Auto saving': -15 °C

The condition for the outdoor temperature influence:
T.out.influence = (10 - T.out) / (10 - setting) =
(10 - (-5)) / (10 - (-15)) =
15 / 25 = 0,6

The corrected desired room temperature in Saving mode:
 T.room.ref.Saving + (T.out.influence x (T.room.ref.Comfort - T.room.ref.Saving))
 16 + (0,6 x (22 - 16)) = 19,6 °C

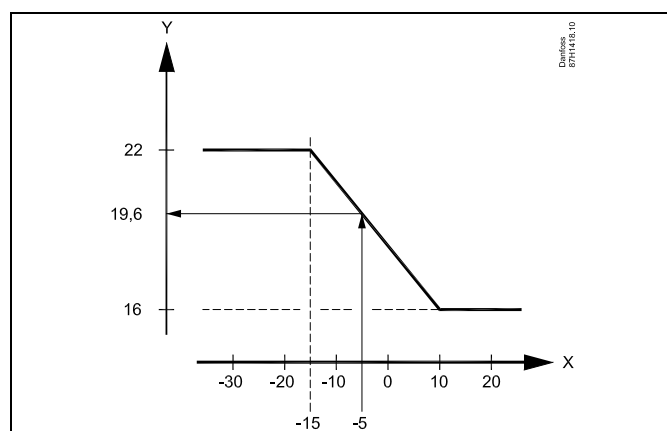

X = Outdoor temperature (°C)
 Y = Desired room temperature (°C)

MENU > Settings > Optimization

Boost	1x012
<i>Shortens the heating-up period by increasing the desired flow temperature by the percentage you set.</i>	

See Appendix "Parameter ID overview"

OFF: The boost function is not active.

Value: The desired flow temperature is increased temporarily with the set percentage.

In order to shorten the heating-up period after a saving temperature period, the desired flow temperature can be increased temporarily (max. 1 hour). At optimizing the boost is active in the optimization period ('Optimizer').

If a room temperature sensor or an ECA 30 / 31 is connected, the boost stops when the room temperature is reached.

MENU > Settings > Optimization

Ramp (reference ramping)	1x013
<i>The time (minutes) in which the desired flow temperature increases gradually to avoid load peaks in the heat supply.</i>	

See Appendix "Parameter ID overview"

OFF: The ramping function is not active.

Value: The desired flow temperature is increased gradually with the set minutes.

In order to avoid load peaks in the supply network, the flow temperature can be set to increase gradually after a period with saving temperature. This causes the valve to open gradually.

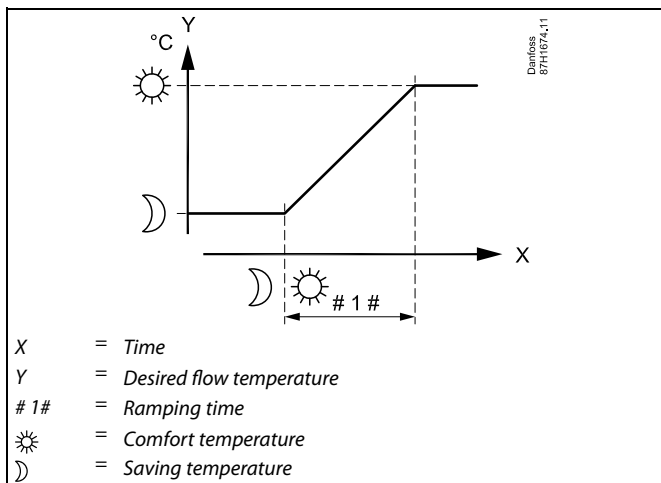

Operating Guide ECL Comfort 210 / 296 / 310, application A266

MENU > Settings > Optimization

Optimizer (optimizing time constant)	1x014
<p>Optimizes the start and stop times for the comfort temperature period to obtain the best comfort at the lowest energy consumption. The lower the outdoor temperature, the earlier the heating cut-in. The lower the outdoor temperature, the later the heating cut-out. The optimized heating cut-out time can be automatic or disabled. The calculated start and stop times are based on the setting of the optimizing time constant.</p>	

See Appendix "Parameter ID overview"

Adjust the optimizing time constant.

The value consists of a two digit number. The two digits have the following meaning (digit 1 = Table I, digit 2 = Table II).

OFF: No optimization. The heating starts and stops at the times set in the schedule.

10 ... 59: See tables I and II.

Table I:

Left digit	Heat accumulation of the building	System type
1-	light	Radiator systems
2-	medium	
3-	heavy	
4-	medium	Floor heating systems
5-	heavy	

Table II:

Right digit	Dimensioning temperature	Capacity
-0	-50 °C	large
-1	-45 °C	.
.	.	.
-5	-25 °C	normal
.	.	.
-9	-5 °C	small

Dimensioning temperature:

The lowest outdoor temperature (usually determined by your system designer in connection with the design of the heating system) at which the heating system can maintain the designed room temperature.

Example

The system type is radiator, and the heat accumulation of the building is medium.

The left digit is 2.

The dimensioning temperature is -25 °C, and the capacity is normal.

The right digit is 5.

Result:

The setting is to be changed to 25.

MENU > Settings > Optimization

Based on (optimization based on room / outdoor temp.)	1x020
<p>The optimized start and stop time can be based on either room or outdoor temperature.</p>	

See Appendix "Parameter ID overview"

OUT: Optimization based on outdoor temperature. Use this setting if the room temperature is not measured.

ROOM: Optimization based on room temperature, if measured.

Operating Guide ECL Comfort 210 / 296 / 310, application A266

MENU > Settings > Optimization

Total stop	1x021
Decide whether you want a total stop during the saving temperature period.	

See Appendix "Parameter ID overview"

- OFF:** No total stop. The desired flow temperature is reduced according to:
- desired room temperature in saving mode
 - auto saving
- ON:** The desired flow temperature is lowered to the set value in 'Frost pr.'. The circulation pump is stopped but frost protection is still active, see 'P frost T'.

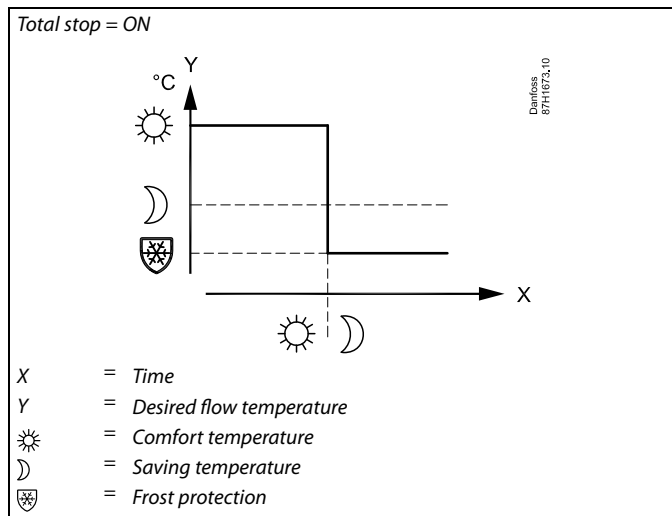
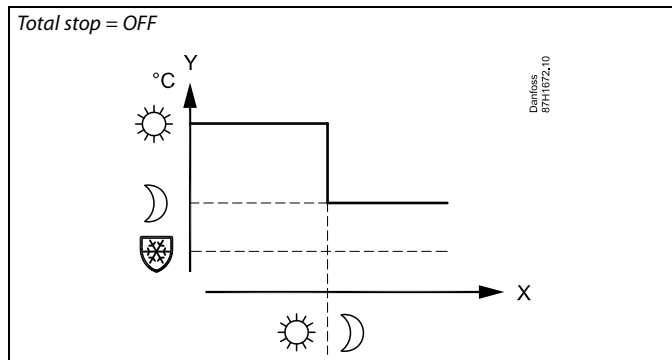

The min. flow temperature limitation ('Temp. min.') is overruled when 'Total stop' is ON.

MENU > Settings > Optimization

Pre-stop (optimized stop time)	1x026
Disable the optimized stop time.	

See Appendix "Parameter ID overview"

- OFF:** The optimized stop time is disabled.
- ON:** The optimized stop time is enabled.

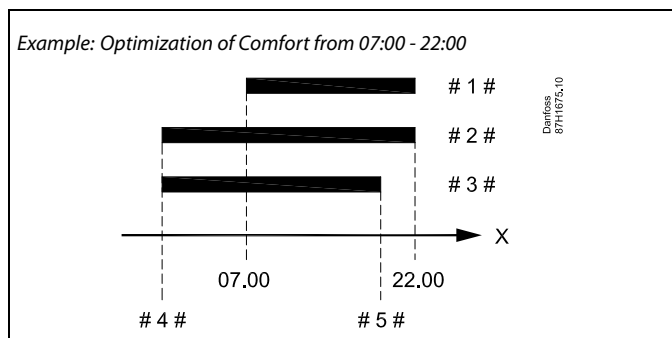

X = Time
 # 1 # = Schedule
 # 2 # = Prestop = OFF
 # 3 # = Prestop = ON
 # 4 # = Optimized start
 # 5 # = Optimized stop

Operating Guide ECL Comfort 210 / 296 / 310, application A266

MENU > Settings > Optimization

Parallel operation	1x043
Choose whether the heating circuit is to operate in dependence of the DHW circuit. This function might be useful if an installation has limited power or flow.	

See Appendix "Parameter ID overview"

OFF: Independent parallel operation, i.e. the DHW and the heating circuits operate independently of each other. It makes no difference whether the desired DHW temperature can be reached or not.

Value: Dependent parallel operation, i.e. the desired heating temperature depends on the DHW demand. Choose how much the DHW temperature can drop before the desired heating temperature has to be decreased.

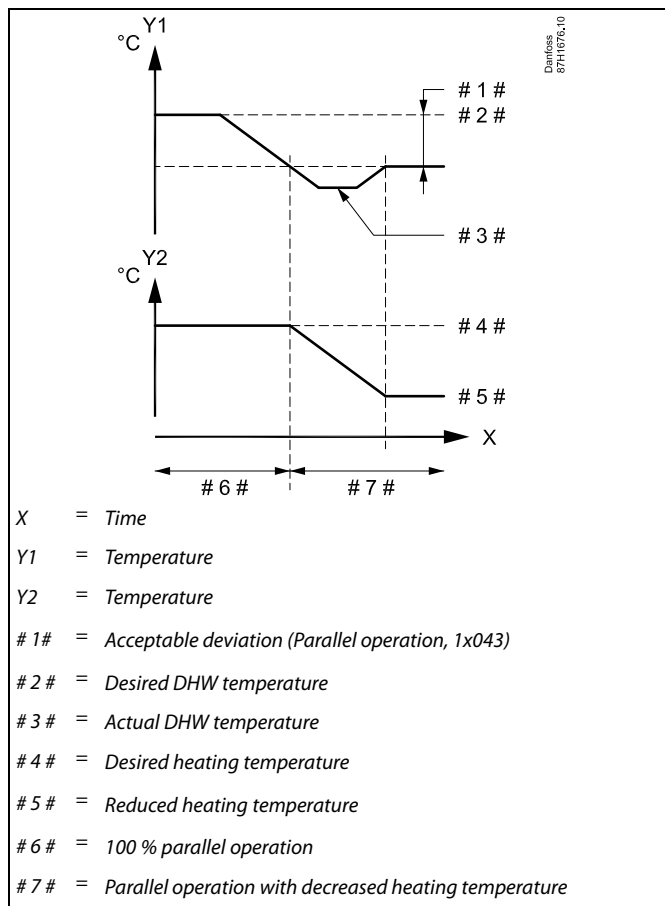

If the actual DHW temperature deviates more than the set value, the gear motor M2 in the heating circuit will gradually close to such an extent that the DHW temperature stabilizes at the lowest acceptable value.



In case the Parallel operation is active (a too low DHW temperature and therefore a reduced heating circuit temperature), a slave's temperature demand will not change the desired flow temperature in the heating circuit.



When dependent parallel operation is in function:

- Desired flow temperature for the heating circuit will be minimum limited, when "Priority for return temperature" (ID 1x085) is set to OFF.
- Desired flow temperature for the heating circuit will not be minimum limited, when "Priority for return temperature" (ID 1x085) is set to ON.

Operating Guide ECL Comfort 210 / 296 / 310, application A266

MENU > Settings > Optimization

Summer, cut-out (limit for heating cut-out)

1x179

See Appendix "Parameter ID overview"

The heating can be switched OFF when the outdoor temperature is higher than the set value. The valve closes and after the post-run time, the heating circulation pump stops. 'Temp. min.' will be overruled.

The heating system switches ON again when the outdoor temperature and the accumulated (filtered) outdoor temperature become lower than the set limit.

This function can save energy.

Set the value for outdoor temperature at which you want the heating system to switch OFF.

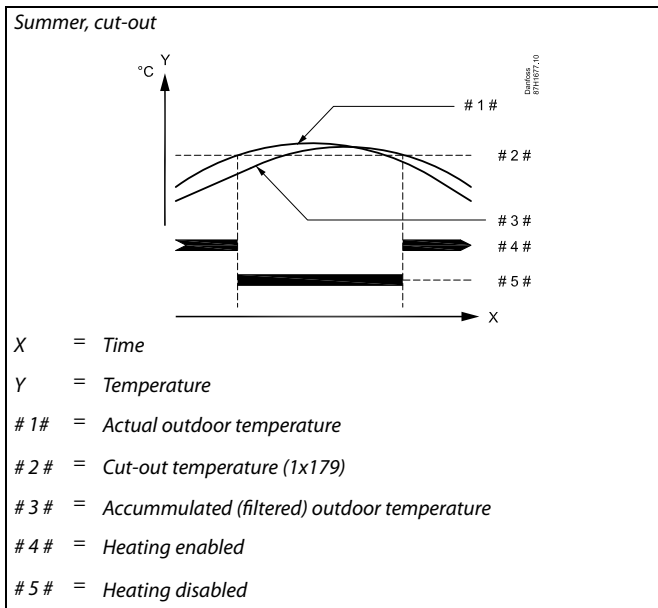

The heating cut-out is only active when the controller mode is in scheduled operation. When the cut-out value is set to OFF, there is no heating cut-out.

5.7 Control parameters

Control of valves

The motorized control valves are controlled by means of 3-point control signal.

Valve control:

The motorized control valve is opened gradually when the flow temperature is lower than the desired flow temperature and vice versa.

The water flow through the control valve is managed by means of an electric actuator. The combination "actuator" and "control valve" is also called motorized control valve. The actuator can in this way gradually increase or decrease the flow in order to change the supplied energy. Different types of actuators are available.

3-point controlled actuator:

The electric actuator contains a reversible gear-motor. Electric "open" and "close" signals come from the electronic outputs of the ECL Comfort controller in order to manage the control valve. The signals are in the ECL Comfort controller expressed as "Arrow-up" (open) and "Arrow-down" (close) and displayed at the valve symbol. When the flow temperature (for example at S3) is lower than the desired flow temperature, short open-signals come from the ECL Comfort controller in order to gradually increase the flow. By this, the flow temperature will align with the desired temperature. Oppositely, when the flow temperature is higher than the desired flow temperature, short close-signals come from the ECL Comfort controller in order to gradually reduce the flow. Again, the flow temperature aligns with the desired temperature. Neither open-signals nor close-signals will come as long as the flow temperature corresponds to the desired temperature.

0 - 10 volt controlled actuator

This electric actuator contains a reversible gear-motor. A control voltage between 0 and 10 volt comes from the extension module ECA 32 in order to manage the control valve. The voltage in the ECL Comfort controller is expressed as a % value and displayed at the valve symbol. Example: 45 % corresponds to 4.5 volt. When the flow temperature (for example at S3) is lower than the desired flow temperature, the control voltage is gradually increased in order to gradually increase the flow. By this, the flow temperature will align with the desired temperature. The control voltage remains on a constant value as long as the flow temperature corresponds to the desired temperature. Oppositely, when the flow temperature is higher than the desired flow temperature, the control voltage is gradually reduced in order to reduce the flow. Again, the flow temperature aligns with the desired temperature.

Operating Guide ECL Comfort 210 / 296 / 310, application A266

Thermo-hydraulic actuator, ABV

Danfoss thermo-actuator type ABV is a slow acting valve actuator. Inside the ABV an electric heat coil will heat a thermostatic element when an electric signal is applied. When heating the thermostatic element it expands in order to manage the control valve.

Two basic types are available: ABV NC (Normal Closed) and ABV NO (normal open). For example, ABV NC keeps a 2-port control valve closed when no open-signals are applied.

Electric open-signals come from the electronic output of the ECL Comfort controller in order to manage the control valve. When open-signals are applied to the ABV NC, the valve gradually opens.

Open-signals are in the ECL Comfort controller expressed as "Arrow-up" (open) and displayed at the valve symbol.

When the flow temperature (for example at S3) is lower than the desired flow temperature, relatively long open-signals come from the ECL Comfort controller in order to increase the flow. By this, the flow temperature will over time be aligned with the desired temperature.

Oppositely, when the flow temperature is higher than the desired flow temperature, relatively short open-signals come from the ECL Comfort controller in order to reduce the flow. Again, the flow temperature aligns, over time, with the desired temperature.

The control of the Danfoss thermo-actuator type ABV uses a unique designed algorithm and is based on the PWM principle (Pulse Width Modulation), where the duration of the pulse determines the management of the control valve. The pulses are repeated each 10 sec.

As long as the flow temperature corresponds to the desired temperature, the duration of the open-signals will remain constant.



Parameters indicated with an ID no. like "1x607" mean a universal parameter.
x stands for circuit / parameter group.

MENU > Settings > Control parameters

Actuator	1x024
ABV / GEAR	GEAR

Selection of valve actuator type.

ABV: Danfoss type ABV (thermo actuator).

GEAR: Gear motor based actuator.



When selecting "ABV", the control parameters:

- Motor protection (ID 1x174)
 - Xp (ID 1x184)
 - Tn (ID 1x185)
 - M run (ID 1x186)
 - Nz (ID 1x187)
 - Min. act. time (ID 1x189)
- are not considered.

Operating Guide ECL Comfort 210 / 296 / 310, application A266

MENU > Settings > Control parameters

Open time	1x094
<p>The 'Open time' is the forced time (in seconds) that it takes to open the motorized control valve when a DHW draw-off (tapping) is detected (the flow switch is activated). This function compensates for the delay before the flow temperature sensor measures a change in temperature.</p>	

See Appendix "Parameter ID overview"

MENU > Settings > Control parameters

Close time	1x095
<p>The 'Close time' is the forced time (in seconds) that it takes to close the motorized control valve when a DHW draw-off (tapping) is stopped (the flow switch is deactivated). This function compensates for the delay before the flow temperature sensor measures a change in temperature.</p>	

See Appendix "Parameter ID overview"

MENU > Settings > Control parameters

Tn (idle)	1x096
<p>When no DHW draw-off (tapping) is detected (the flow switch is deactivated), the temperature is maintained at a low level (saving temperature). The integration time 'Tn (idle)' can be set to obtain a slow but stable control.</p>	

See Appendix "Parameter ID overview"

MENU > Settings > Control parameters

Supply T (idle)	1x097
<p>The 'supply T (idle)' is the supply temperature when there is no DHW draw-off (tapping). When DHW draw-off is not detected (the flow switch is deactivated), the temperature is maintained at a lower level (saving temperature). Choose which temperature sensor is to maintain the saving temperature.</p>	

See Appendix "Parameter ID overview"

- OFF:** The saving temperature is maintained at the DHW flow temperature sensor.
- ON:** The saving temperature is maintained at the supply temperature sensor.



If the supply temperature sensor is not connected, the idle supply temperature will be maintained at the DHW flow temperature sensor.

Operating Guide ECL Comfort 210 / 296 / 310, application A266

MENU > Settings > Control parameters

Auto tuning	1x173
<i>Automatically determines the control parameters for the DHW control. 'Xp', 'Tn' and 'M run' do not need to be set, when using auto tuning. 'Nz' must be set.</i>	

See Appendix "Parameter ID overview"

OFF: Auto tuning is not activated.

ON: Auto tuning is activated.

The auto tuning function automatically determines the control parameters for DHW control. Thus you do not need to set the 'Xp', 'Tn' and 'M run', as they are automatically set when the auto tuning function is set to ON.

Auto tuning is typically used in connection with the installation of the controller, but it can be activated when needed, e.g. for an extra check of the control parameters.

Before starting the auto tuning, the tapping flow should be adjusted to the relevant value (see table).

If possible, any additional DHW consumption should be avoided during the auto tuning process. Should the tapping load vary too much, the auto tuning and controller will return to the default settings.

Auto tuning is activated by setting the function to ON. When the auto tuning is ended, the function is automatically converted to OFF (default setting). This will be indicated in the display.

The auto tuning process takes up to 25 minutes.

No. of apartments	Heat transfer (kW)	Constant DHW draw-off (l / min)
1-2	30-49	3 (or 1 tap 25% open)
3-9	50-79	6 (or 1 tap 50% open)
10-49	80-149	12 (or 1 tap 100% open)
50-129	150-249	18 (or 1 tap 100% + 1 tap 50% open)
130-210	250-350	24 (or 2 taps 100% open)



In order to meet the summer- / winter variations, the ECL clock must be set to the correct date for an successful auto tuning.

The motor protection function ('Motor pr.') has to be deactivated during auto tuning. During auto tuning the circulation pump for tap water must be switched off. This is done automatically if the pump is controlled by the ECL controller.

Auto tuning is only applicable in connection with valves that are approved for auto tuning, i.e. the Danfoss types VB 2 and VM 2 with split characteristic as well as logarithmic valves such as VF and VFS.

MENU > Settings > Control parameters

Motor pr. (motor protection)	1x174
<i>Prevents the controller from unstable temperature control (and resulting actuator oscillations). This can occur at very low load. The motor protection increases the lifetime of all involved components.</i>	

See Appendix "Parameter ID overview"

OFF: Motor protection is not activated.

Value: Motor protection is activated after the set activation delay in minutes.



Recommended for duct systems with variable load.

MENU > Settings > Control parameters

Xp (proportional band)	1x184
-------------------------------	--------------

See Appendix "Parameter ID overview"

Set the proportional band. A higher value will result in a stable but slow control of the flow temperature.

Operating Guide ECL Comfort 210 / 296 / 310, application A266

MENU > Settings > Control parameters

Xp actual
<i>'Xp actual' is the read-out of the actual Xp (proportional band) based on the supply temperature. Xp is determined by settings related to the supply temperature. Typically, the higher the supply temperature, the higher the Xp must be in order to achieve a stable temperature control.</i>

Xp setting range: 5 ... 250 K
 Fixed supply temperature settings: 65 °C and 90 °C
 Factory settings: (65,40) and (90,120)

This means that the 'Xp' is 40 K at 65 °C supply temperature, and 'Xp' is 120 K at 90 °C.

Set the desired Xp values at the two fixed supply temperatures.

If the supply temperature is not measured (the supply temperature sensor is not connected), the Xp value at the setting 65 °C is used.

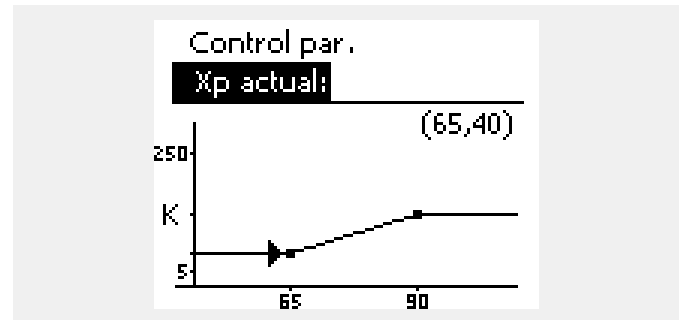

MENU > Settings > Control parameters

Tn (integration time constant)	1x185
---------------------------------------	--------------

See Appendix "Parameter ID overview"

Set a high integration time constant (in seconds) to obtain a slow but stable reaction to deviations.

A low integration time constant will make the controller react fast but with less stability.

MENU > Settings > Control parameters

M run (running time of the motorized control valve)	1x186
<i>'M run' is the time in seconds it takes the controlled component to move from fully closed to fully open position.</i>	

See Appendix "Parameter ID overview"

Set the 'M run' according to the examples or measure the running time by means of a stop watch.

How to calculate the running time of a motorized control valve
 The running time of the motorized control valve is calculated using the following methods:

Seated valves
 Running time = Valve stroke (mm) x actuator speed (sec. / mm)
Example: 5.0 mm x 15 sec. / mm = 75 sec.

Rotating valves
 Running time = Turning degrees x actuator speed (sec. / degr.)
Example: 90 degr. x 2 sec. / degr. = 180 sec.

MENU > Settings > Control parameters

Nz (neutral zone)	1x187
<i>When the actual flow temperature is within the neutral zone, the controller does not activate the motorized control valve.</i>	

The neutral zone is symmetrical around the desired flow temperature value, i.e. half the value is above and half the value is below this temperature.

See Appendix "Parameter ID overview"

Set the acceptable flow temperature deviation.

Set the neutral zone to a high value if you can accept a high variation in flow temperature.

Operating Guide ECL Comfort 210 / 296 / 310, application A266

MENU > Settings > Control parameters

Min. act. time (min. activation time gear motor)	1x189
<i>The min. pulse period of 20 ms (milliseconds) for activation of the gear motor.</i>	

See Appendix "Parameter ID overview"

Setting example	Value x 20 ms
2	40 ms
10	200 ms
50	1000 ms

 The setting should be kept as high as acceptable to increase the lifetime of the actuator (gear motor).

If you want to tune the PI regulation precisely, you can use the following method:

- Set the 'Tn' (integration time constant) to its max. value (999 sec.).
- Decrease the value for the 'Xp' (proportional band) until the system starts hunting (i.e. gets unstable) with a constant amplitude (it might be necessary to force the system by setting an extreme low value).
- Find the critical time period on the temperature recorder or use a stop watch.

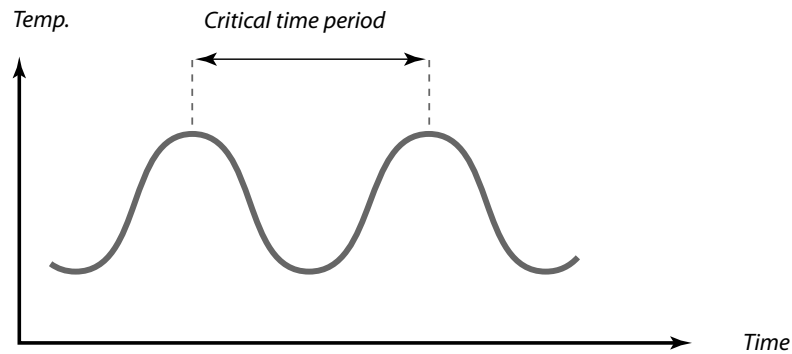

This critical time period will be characteristic for the system, and you can evaluate the settings from this critical period.

'Tn' = 0.85 x critical time period

'Xp' = 2.2 x proportional band value in the critical time period

If the regulation seems to be too slow, you can decrease the proportional band value by 10%. Make sure there is a consumption when you set the parameters.

5.8 Application

The section "Application" describes specific application related issues.

Some of the parameter descriptions are universal for different application keys.



Parameters indicated with an ID no. like "1x607" mean a universal parameter.
x stands for circuit / parameter group.

MENU > Settings > Application

ECA addr. (ECA address, choice of Remote Control Unit)	1x010
---	--------------

Decides the room temperature signal transfer and communication with the Remote Control Unit.



The Remote Control Unit must be set accordingly (A or B).

See Appendix "Parameter ID overview"

OFF: No Remote Control Unit. Only room temperature sensor, if any.

A: Remote Control Unit ECA 30 / 31 with address A.

B: Remote Control Unit ECA 30 / 31 with address B.

MENU > Settings > Application

Demand offset	1x017
----------------------	--------------

The desired flow temperature in heating circuit 1 can be influenced by the demand for a desired flow temperature from another controller (slave) or another circuit.

See Appendix "Parameter ID overview"

OFF: The desired flow temperature in circuit 1 is not influenced by the demand of any other controller (slave or circuit 2).

Value: The desired flow temperature is increased by the set value in 'Demand offset', if the demand of the slave / circuit 2 is higher.

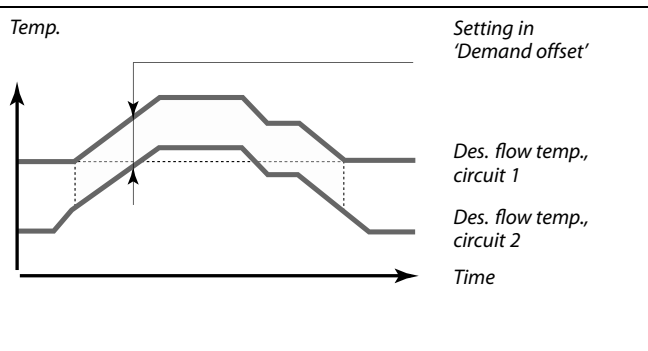

The function of 'Demand offset' can compensate for heat losses between master and slave controlled systems.



When setting "Demand offset" to a value, the return temperature limitation will react according to the highest limitation value (Heating / DHW).

Operating Guide ECL Comfort 210 / 296 / 310, application A266

MENU > Settings > Application

P exercise (pump exercise)	1x022
<i>Exercises the pump to avoid blocking in periods without heat demand.</i>	

See Appendix "Parameter ID overview"

OFF: The pump exercise is not active.

ON: The pump is switched ON for 1 minute every third day at noon (12:14 hours).

MENU > Settings > Application

M exercise (valve exercise)	1x023
<i>Exercises the valve to avoid blocking in periods without heat demand.</i>	

See Appendix "Parameter ID overview"

OFF: The valve exercise is not active.

ON: The valve opens for 7 minutes and closes for 7 minutes every third day at noon (12:00 hours).

MENU > Settings > Application

P post-run	1x040
<p>Heating applications: <i>The circulation pump in the heating circuit can be ON for a number of minutes (m) after heating stop. Heating stop is when the desired flow temperature gets lower than the setting in 'P heat T' (ID no. 1x078).</i></p> <p>Cooling applications: <i>The circulation pump in the cooling circuit can be ON for a number of minutes (m) after cooling stop. Cooling stop is when the desired flow temperature gets higher than the setting in 'P cool T' (ID no. 1x070). This P post-run function can utilize the remaining energy in for example a heat exchanger.</i></p>	

See Appendix "Parameter ID overview"

0: The circulation pump stops immediately after heating or cooling stop.

Value: The circulation pump is ON for the set time after heating or cooling stop.

Operating Guide ECL Comfort 210 / 296 / 310, application A266

MENU > Settings > Application

P demand	1x050
<i>The circulation pump in the master circuit can be controlled in relation to the master circuit's demand or slave circuit's demand.</i>	



The circulation pump is always controlled according to frost protection conditions.

See Appendix "Parameter ID overview"

Heating applications:

- OFF:** The circulation pump is ON when the desired flow temperature in the heating circuit is higher than the value set in 'P heat T'.
- ON:** The circulation pump is ON when the desired flow temperature from slaves is higher than the value set in 'P heat T'.

Cooling applications:

- OFF:** The circulation pump is ON when the desired flow temperature in the cooling circuit is lower than the value set in 'P cool T'.
- ON:** The circulation pump is ON when the desired flow temperature from slaves is lower than the value set in 'P cool T'.

MENU > Settings > Application

DHW priority (closed valve / normal operation)	1x052
<i>The heating circuit can be closed when the controller acts as slave and when DHW heating / charging is active in the master.</i>	



This setting must be considered if this controller is a slave.

See Appendix "Parameter ID overview"

- OFF:** The flow temperature control remains unchanged during active DHW heating / charging in the master controller.
- ON:** The valve in the heating circuit is closed* during active DHW heating / charging in the master controller.
* *The desired flow temperature is set to the value set in 'Frost pr. T'*

MENU > Settings > Application

P frost T (circulation pump, frost protection temp.)	1x077
<i>Frost protection, based on the outdoor temperature. When the outdoor temperature gets below the set temperature value in 'P frost T', the controller automatically switches ON the circulation pump (for example P1 or X3) to protect the system.</i>	



Under normal conditions, your system is not frost protected if your setting is below 0 °C or OFF.
For water-based systems, a setting of 2 °C is recommended.

See Appendix "Parameter ID overview"

- OFF:** No frost protection.
- Value:** Circulation pump is ON when the outdoor temperature is below the set value.



If the outdoor temperature sensor is not connected and the factory setting has not been changed to 'OFF', the circulation pump is always ON.

Operating Guide ECL Comfort 210 / 296 / 310, application A266

MENU > Settings > Application

P heat T (heat demand)	1x078
<i>When the desired flow temperature is above the set temperature in 'P heat T', the controller automatically switches ON the circulation pump.</i>	



The valve is fully closed as long as the pump is not switched on.

See Appendix "Parameter ID overview"

Value: The circulation pump is switched ON when the desired flow temperature is above the set value.

MENU > Settings > Application

Frost pr. T (frost protection temp.)	1x093
<i>Set the desired flow temperature at temperature sensor S3 to protect the system against frost (at heating cut-out, total stop etc.). When the temperature at S3 gets lower than the setting, the motorized control valve opens gradually.</i>	



The frost protection temperature can also be set in your favorite display when the mode selector is in frost protection mode.

See Appendix "Parameter ID overview"

Operating Guide ECL Comfort 210 / 296 / 310, application A266

Override mode functions:

The following settings describe the function in general for the ECL Comfort 210 / 296 / 310 series. The explained modes are typical and not application related. They might differ from the override modes in your application.

MENU > Settings > Application

Ext. input (external override)	1x141
---------------------------------------	--------------

Choose the input for 'Ext. input' (external override). By means of a switch the controller can be overridden to 'Comfort', 'Saving', 'Frost protection' or 'Constant temperature' mode.

See Appendix "Parameter ID overview"

OFF: No inputs have been selected for external override.

S1 ... S16: Input selected for external override.

If S1... S6 is chosen as override input, the override switch must have gold-plated contacts.

If S7 ... S16 is chosen as override input, the override switch can be a standard contact.

See the drawings for connection examples of override switch and override relay to input S8.

S7...S16 are recommended for override switch.

If ECA 32 is mounted, also S11... S16 can be used.

If ECA 35 is mounted, also S11 or S12 can be used.

Example: Connection of an override switch

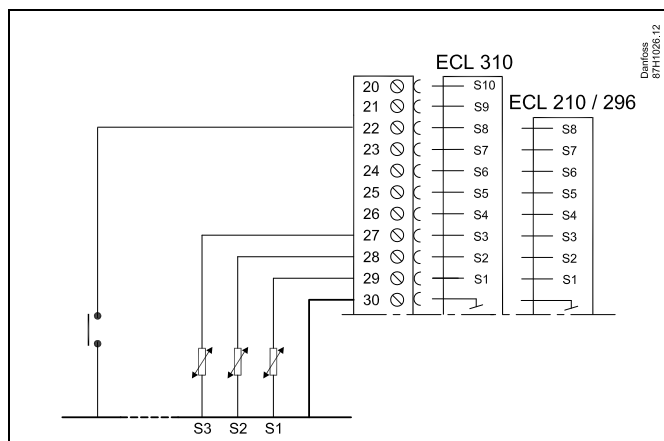

Example: Connection of an override relay

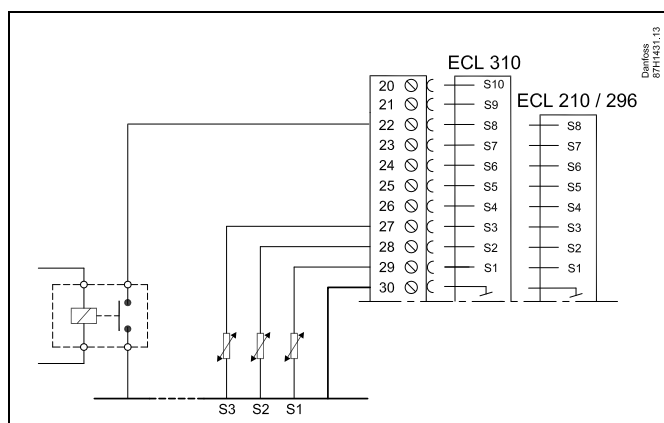

Choose only an unused input for override. If an already used input is applied for override, the functionality of this input is also neglected.



See also 'Ext. mode'.

Operating Guide ECL Comfort 210 / 296 / 310, application A266

MENU > Settings > Application

Ext. mode (external override mode)	1x142
<i>The mode override can be activated for Saving, Comfort, Frost pr. or Constant T mode. For override, the controller mode must be in scheduled mode.</i>	

See Appendix "Parameter ID overview"

Choose an override mode:

- SAVING:** The circuit in question is in saving mode when the override switch is closed.
- COMFORT:** The circuit in question is in comfort mode when the override switch is closed.
- FROST PR.:** The heating or DHW circuit closes, but is still frost protected.
- CONSTANT T:** The circuit in question controls a constant temperature *)

*) See also 'Desired T' (1x004), setting of desired flow temperature (MENU > Settings > Flow temperature)
See also 'Con. T, ret. T lim.' (1x028), setting of return temperature limitation (MENU > Settings > Return limit)

The process diagrams show the functionality.



Example: Override to Comfort mode

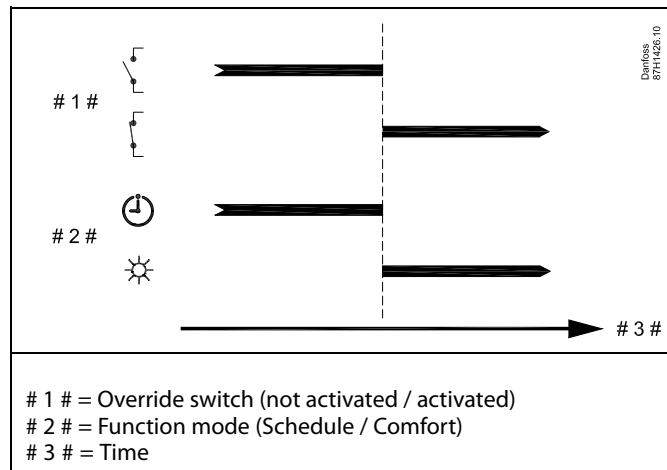

Example: Override to Saving mode

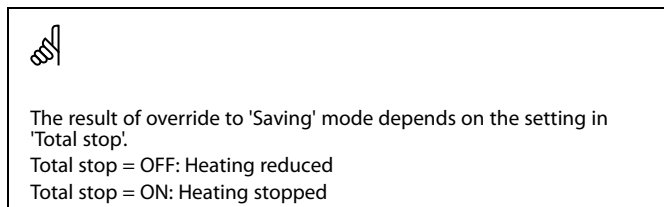
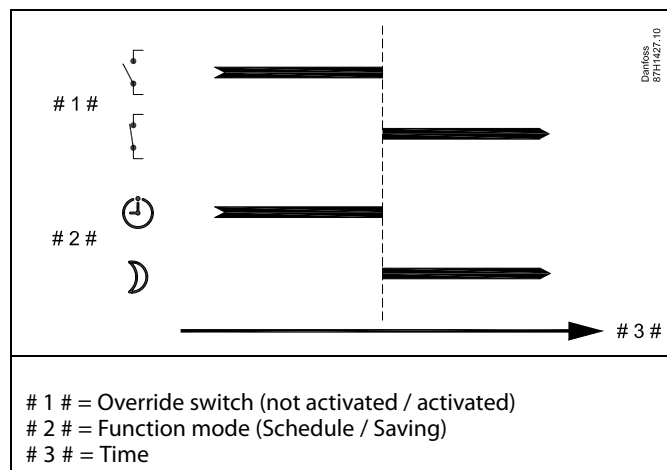

Example: Override to Frost protection mode

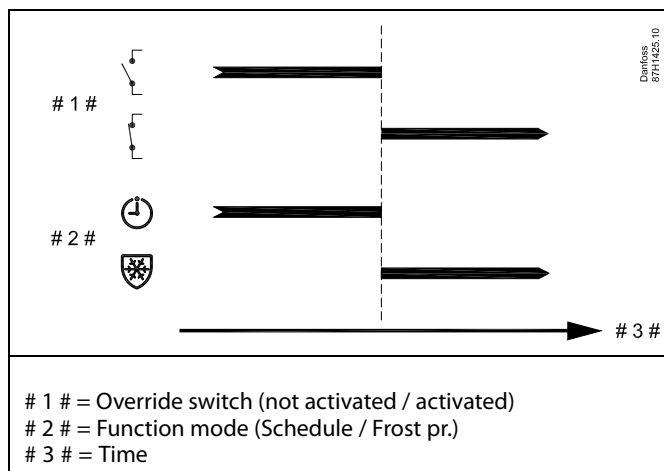

Example: Override to Constant temperature mode

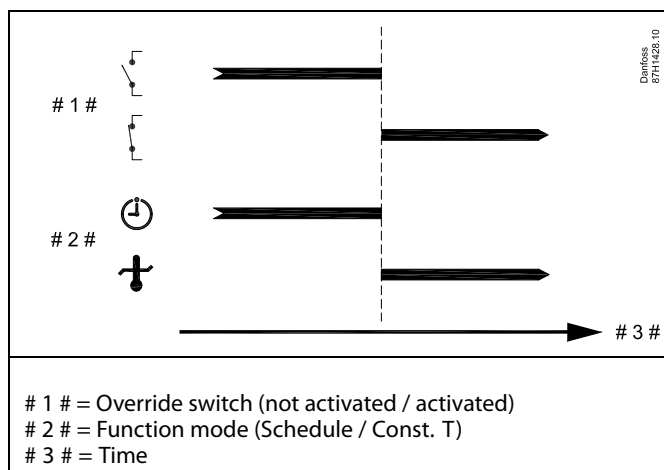

The "Const. T" value can be influenced by:

- temp. max.
- temp. min.
- room temp. limit
- return temp. limit
- flow / power limit

Operating Guide ECL Comfort 210 / 296 / 310, application A266

MENU > Settings > Application

Send desired T	1x500
<p><i>When the controller acts as a slave controller in a master / slave system, information about the desired flow temperature can be sent to the master controller via the ECL 485 bus.</i></p> <p><i>Stand-alone controller: Sub-circuits can send the desired flow temperature to the master circuit.</i></p>	

See Appendix "Parameter ID overview"

OFF: Information about the desired flow temperature is not sent to the master controller.

ON: Information about the desired flow temperature is sent to the master controller.



In the master controller, 'Demand offset' must be set to a value in order to react on a desired flow temperature from a slave controller.



When the controller acts as a slave, its address must be 1, 2, 3 ... 9 in order to send the desired temperature to the master (see the section 'Miscellaneous', 'Several controllers in the same system').

5.9 Heat cut-out

MENU > Settings > Heat cut-out

The setting "Summer cut-out" under "Optimization" for the heating circuit in question determines a heating cut-out when the outdoor temperature exceeds the set value.

A filtering constant for calculating the accumulated outdoor temperature is internally set to a value of "250". This filtering constant represents an average building with solid outer and inner walls (bricks).

An option for differentiated cut-out temperatures, based on a set summer period, can be utilized in order to avoid discomfort at falling outdoor temperature. Furthermore, separate filtering constants can be set.

The factory set values for Summer period start and Winter period start are set to same date: May, 20 (Date = 20, Month = 5).

This means:

- "Differentiated cut-out temperatures" are disabled (not active)
- Separate "Filtering constant" values are disabled (not active)

In order to enable differentiated

- cut-out temperature based on summer / winter period
- filtering constants

the start dates for the periods must be different.

5.9.1 Differentiated heat cut-out

To set differentiated cut-out parameters for a heating circuit for "Summer" and "Winter" go to "Heat cut-out":

(MENU > Settings > Heat cut-out)

This function is active when the dates for "Summer" and "Winter" are different in the "Heat cut-out" menu.

Parameters indicated with an ID no. like "1x607" mean a universal parameter.
x stands for circuit / parameter group.

MENU > Settings > Heat cut-out

Extended heat cut-out setting			
Parameter	ID	Setting range	Factory setting
Summer day	1x393	*	*
Summer month	1x392	*	*
Summer cut-out	1x179	*	*
Summer filter	1x395	*	*

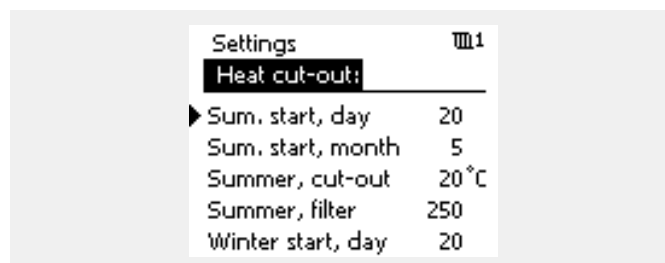

See Appendix "Parameter ID overview"

MENU > Settings > Heat cut-out

Extended winter cut-out setting			
Parameter	ID	Setting range	Factory setting
Winter day	1x397	*	*
Winter month	1x396	*	*
Winter cut-out	1x398	*	*
Winter filter	1x399	*	*

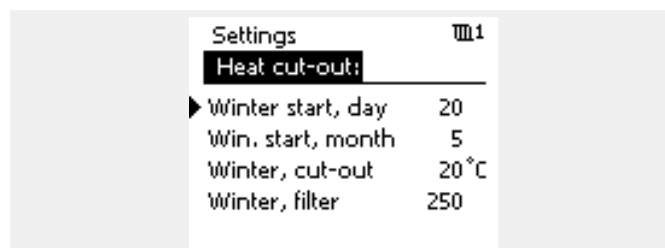

See Appendix "Parameter ID overview"

The above settings of the dates for the cut-out function are only to be done in the heating circuit 1 and are valid for other heating circuits in the controller as well, if applicable.

The cut-out temperatures as well as the filter constant are to be set individually per heating circuit.

The heating cut-out is only active when the controller mode is in scheduled operation. When the cut-out value is set to OFF, there is no heating cut-out.

5.9.2 Summer/winter filter constant

The filter constant of 250 is applicable for average buildings. A filter constant of 1 is close switching according to actual outdoor temperature meaning low filtering (very "light" building).

A filter constant of 300 is then to be chosen if a big filtering is needed (very heavy building).

For heating circuits where the heat cut-out is demanded according to the same outdoor temperature for the whole year, but different filtering is wanted, different dates have to be set in the "Heat cut-out" menu enabling a selection of a filter constant different from the factory setting.

These different values have to be set in both the "Summer" and "Winter" menu.

Settings	U1
Heat cut-out:	
Sum. start, day	20
Sum. start, month	5
Summer, cut-out	20 °C
▶ Summer, filter	100
Winter start, day	21

Settings	U1
Heat cut-out:	
Winter start, day	21
Win. start, month	5
Winter, cut-out	20 °C
▶ Winter, filter	250

5.10 Alarm

The section "Alarm" describes specific application related issues.

Application A266 offers different types of alarms:

1. Actual flow temperature differs from the desired flow temperature (A266.1, A266.2)
2. Disconnection or short-circuiting of a temperature sensor or its connection
3. Max. temperature in heating circuit (A266.2, A266.9, A266.10)
4. Activation of alarm input (A266.9, A266.10)
5. Pressure alarm (A266.9, A266.10)

The alarm functions activate the alarm bell symbol.

The alarm functions activate A1 (relay 4).

The alarm relay can activate a lamp, a horn, an input to an alarm transmitting device etc.

The alarm symbol / relay is activated:

- as long as the alarm reason is present (automatic reset).

Alarm type 1:

If the flow temperature deviates more than the set differences from the desired flow temperature, the alarm symbol / relay will be activated.

If the flow temperature becomes acceptable, the alarm symbol / relay will be de-activated.

Alarm type 2:

Selected temperature sensors can be monitored.

Should the connection to the temperature sensor be disconnected, short-circuited or the sensor gets defective, the alarm symbol / relay will be activated. In the "Raw input overview" (MENU > Common controller settings > System > Raw input overview) the sensor in question is marked and the alarm can be reset.

Alarm type 3:

If the flow temperature exceeds the alarm temperature value, the circulation pump is switched OFF, the control valve closes and the alarm symbol / relay will be activated. This safety function can, for example, prevent a too high flow temperature in the floor circuit. When the flow temperature gets 5 K below the alarm value, the circulation pump will be switched ON, the control valve will operate normally and the alarm symbol / relay will be de-activated.

Alarm type 4:

When the alarm input S8 is activated, the alarm symbol / relay will be activated after a set delay.

When the alarm input S8 is de-activated, the alarm symbol / relay will be de-activated.

Alarm type 5:

When the pressure gets higher or lower than set limits, the alarm symbol / relay will be activated after a set delay.

When the pressure gets acceptable, the alarm symbol / relay will be de-activated.

When an alarm is activated, the  appears in the right favorite displays.

Operating Guide ECL Comfort 210 / 296 / 310, application A266

To find the reason for an alarm:

- select MENU
- select 'Alarm'
- select 'Alarm overview': A "bell" will be shown at the alarm in question.

Alarm overview (example):

2: Max. temp.

3: Temp. monitor

32: T sensor defect

The numbers in the 'Alarm overview' refer to the alarm number in the Modbus communication.

To reset an alarm:

When the "bell" is present to the right of the alarm line, place the cursor at the alarm line in question and press the dial.

To reset alarm 32:

MENU > Common controller settings > System > Raw input

overview: The sensor in question is marked and the alarm can be reset.



Parameters indicated with an ID no. like "1x607" mean a universal parameter.
x stands for circuit / parameter group.

MENU > Settings > Alarm

Max. flow T (Maximum flow temperature)	1x079
---	--------------

*The maximum acceptable flow temperature is set here.
When the flow temperature gets higher than the set value, the alarm symbol / relay go ON.
When the flow temperature gets 5 K below the set value, the alarm symbol / relay go OFF.*



Also observe the settings:
* Delay' (ID 1x080)

See Appendix "Parameter ID overview"

Value: Set the acceptable maximum flow temperature

MENU > Settings > Alarm

Delay	1x080
--------------	--------------

If an alarm condition from 'Max. flow T' is present for a longer time than the set delay (in seconds), the alarm function is activated.



Also observe the settings:
* 'Max. flow T' (ID 1x079)

See Appendix "Parameter ID overview"

Value: The alarm function will be activated if the alarm condition remains after the set delay.

Operating Guide ECL Comfort 210 / 296 / 310, application A266

MENU > Settings > Alarm

Upper difference	1x147
<i>The alarm is activated if the actual flow temperature increases more than the set difference (acceptable temperature difference above the desired flow temperature). See also 'Delay'.</i>	

See Appendix "Parameter ID overview"

OFF: The related alarm function is not active.

Value: The alarm function is active if the actual temperature gets above the acceptable difference.

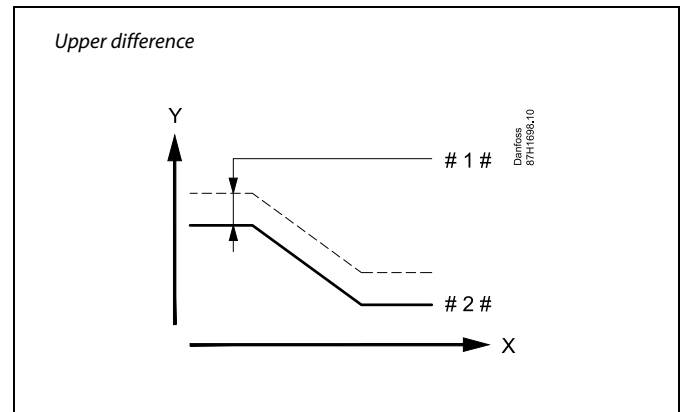

X = Time
 Y = Temperature
 # 1 # = Upper difference
 # 2 # = Desired flow temperature

MENU > Settings > Alarm

Lower difference	1x148
<i>The alarm is activated if the actual flow temperature decreases more than the set difference (acceptable temperature difference below the desired flow temperature). See also 'Delay'.</i>	

See Appendix "Parameter ID overview"

OFF: The related alarm function is not active.

Value: The alarm function is active if the actual temperature gets below the acceptable difference.

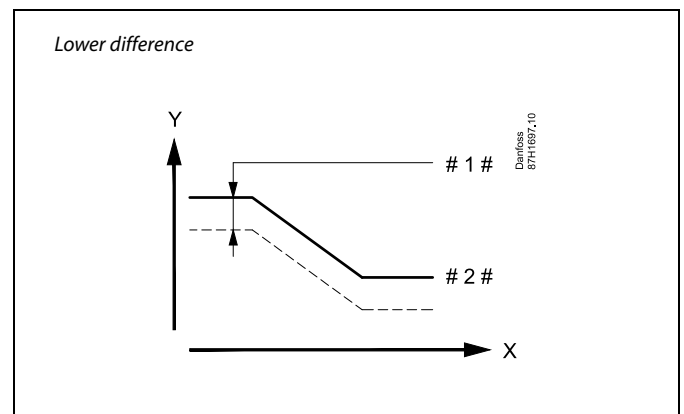

X = Time
 Y = Temperature
 # 1 # = Lower difference
 # 2 # = Desired flow temperature

Operating Guide ECL Comfort 210 / 296 / 310, application A266

MENU > Settings > Alarm

Delay, example 1x149

If an alarm condition from either 'Upper difference' or 'Lower difference' is present for a longer time than the set delay (in minutes), the alarm function is activated.

See Appendix "Parameter ID overview"

Value: The alarm function will be activated if the alarm condition remains after the set delay.

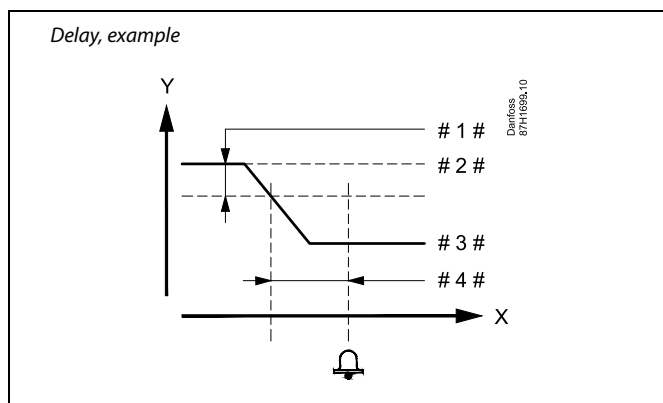

- X = Time
- Y = Temperature
- # 1 # = Lower difference
- # 2 # = Desired flow temperature
- # 3 # = Actual flow temperature
- # 4 # = Delay (ID 1x149)

MENU > Settings > Alarm

Lowest temp. 1x150

The alarm function will not be activated if the desired flow temperature is lower than the set value.

If the cause of the alarm disappears, the alarm indication and output also disappear.

See Appendix "Parameter ID overview"

MENU > Settings > Alarm

Low X 1x607

The pressure is measured by means of a pressure transmitter. The transmitter sends the measured pressure as a 0-10 V or a 4-20 mA signal.

A voltage signal can be applied directly to input S7. A current signal is converted by means of a resistor to a voltage and then applied to input S7. The measured voltage on input S7 must be converted to a pressure value by the controller. This and the following setting set up the conversion.

'Low X' defines the voltage value for the lowest pressure value ('Low Y').

See Appendix "Parameter ID overview"

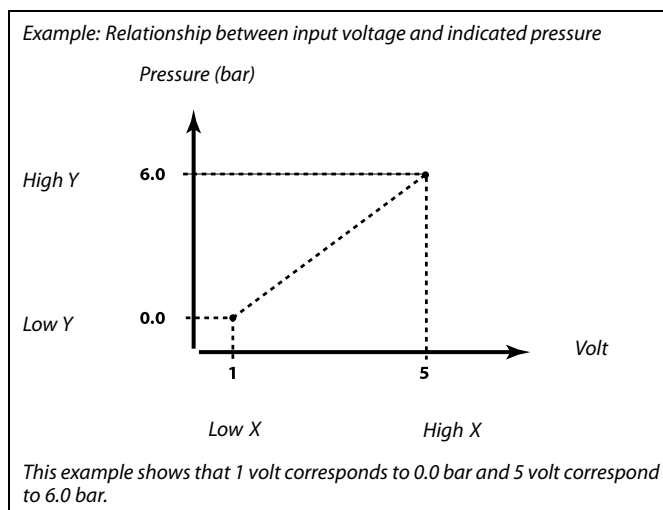

MENU > Settings > Alarm

High X 1x608

The measured voltage on input S7 must be converted to a pressure value. High X defines the voltage value for the highest pressure value ('High Y').

See Appendix "Parameter ID overview"

Operating Guide ECL Comfort 210 / 296 / 310, application A266

MENU > Settings > Alarm

Low Y	1x609
<i>The measured voltage on input S7 must be converted to a pressure value. Low Y defines the pressure value for the lowest voltage value ('Low X').</i>	

See Appendix "Parameter ID overview"

MENU > Settings > Alarm

High Y	1x610
<i>The measured voltage on input S7 must be converted to a pressure value. High Y defines the pressure value for the highest voltage value ('High X').</i>	

See Appendix "Parameter ID overview"

MENU > Settings > Alarm

Alarm high	1x614
<i>When the measured value gets higher than the set value, the alarm will be activated.</i>	

See Appendix "Parameter ID overview"

Value: Set the alarm value

MENU > Settings > Alarm

Alarm low	1x615
<i>When the measured value gets lower than the set value, the alarm will be activated.</i>	

See Appendix "Parameter ID overview"

Value: Set the alarm value

MENU > Settings > Alarm

Alarm time-out	1x617
<i>The alarm is activated when the alarm reason has been present for a longer time (in seconds) than the set value.</i>	

See Appendix "Parameter ID overview"

Value: Set the alarm time-out

Operating Guide ECL Comfort 210 / 296 / 310, application A266

MENU > Settings > Alarm

Alarm value	1x636
<i>Activation of the alarm input can be done by means of closing or opening a contact.</i>	

See Appendix "Parameter ID overview"

0: The alarm is activated when the contacts close.

1: The alarm is activated when the contacts open.



An active alarm is indicated by a  in the display.

S8 input status:

MENU > Common controller > System > Raw input overview > S8:

0 = Input activated. 1 = input not activated

See also 'Alarm time-out', parameter 1x637.

MENU > Settings > Alarm

Alarm time-out	1x637
<i>The alarm is activated when the alarm reason has been present for a longer time (in seconds) than the set value.</i>	

See Appendix "Parameter ID overview"

Value: Set the alarm time-out

5.11 Alarm overview

MENU > Alarm > Alarm overview

This menu shows the alarm types, for example:

- "2: Temp. monitor"
- "32: T sensor defect"

The alarm has been activated if the alarm symbol (a bell) (🔔) is present to the right of the alarm type.



Resetting an alarm, in general:

MENU > Alarm > Alarm overview:
Look for alarm symbol in specific line.

(Example: "2: Temp. monitor")
Move cursor to the line in question.
Push dial.



Alarm overview:

Alarm sources are listed in this overview menu.

Some examples:
"2: Temp. monitor"
"5: Pump 1"
"10: Digital S12"
"32: T sensor defect"

Related to the examples, the numbers 2, 5 and 10 are used in the alarm communication to the BMS / SCADA system.

Related to the examples, "Temp. monitor", "Pump 1" and "Digital S12" are the alarm points.

Related to the examples, "32: T sensor defect" indicates the monitoring of connected sensors.

Alarm numbers and alarm points might differ depending on actual application.

5.12 Anti-bacteria

On selected days during the week the DHW temperature can be increased in order to neutralize bacteria in the DHW system. The desired DHW temperature 'Desired T' (typically 80 °C) will be present for the selected day(s) and duration. The anti-bacteria function is not active in frost protection mode.

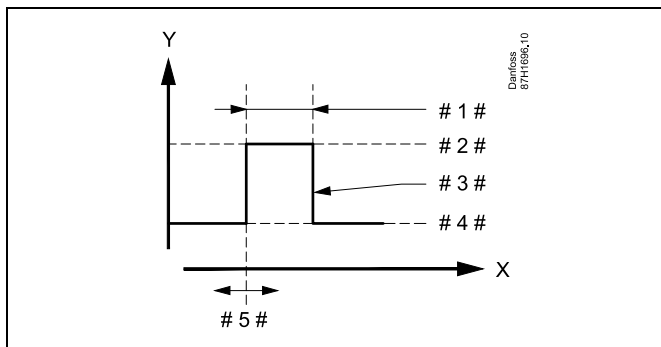

- X = Time
- Y = Desired DHW temperature
- # 1 # = Duration
- # 2 # = Desired Anti-bacteria temperature value
- # 3 # = Desired Anti-bacteria temperature
- # 4 # = Desired DHW temperature value
- # 5 # = Start time



During the anti-bacteria process, the return temperature limitation is not active.

MENU > Settings > Anti-bacteria

Day
Select (mark) the day(s) of the week where the anti-bacteria function must be active.

- M = Monday
- T = Tuesday
- W = Wednesday
- T = Thursday
- F = Friday
- S = Saturday
- S = Sunday

MENU > Settings > Anti-bacteria

Start time
<i>Set the start time for the anti-bacteria function.</i>

MENU > Settings > Anti-bacteria

Duration
<i>Set the duration (minutes) for the anti-bacteria function.</i>

MENU > Settings > Anti-bacteria

Desired T
<i>Set the desired DHW temperature for the anti-bacteria function.</i>

See Appendix "Parameter ID overview"

OFF: The anti-bacteria function is not active.

Value: Desired DHW temperature during the anti-bacteria function period.

6.0 Common controller settings

6.1 Introduction to 'Common controller settings'

Some general settings which apply to the entire controller are located in a specific part of the controller.

To enter 'Common controller settings':

Action:	Purpose:	Examples:
	Choose 'MENU' in any circuit	MENU
	Confirm	
	Choose the circuit selector at the top right corner in the display	
	Confirm	
	Choose 'Common controller settings'	
	Confirm	

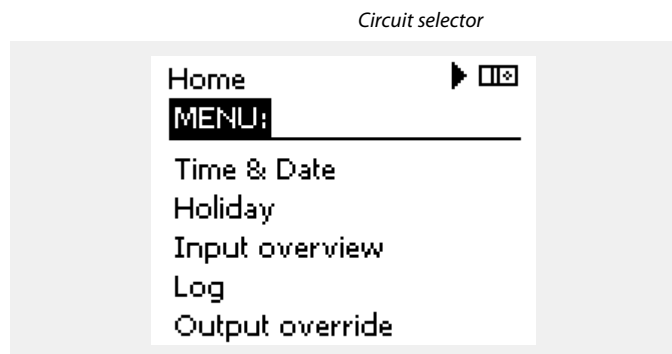

Operating Guide ECL Comfort 210 / 296 / 310, application A266

6.2 Time & Date

It is only necessary to set the correct date and time in connection with the first use of the ECL Comfort controller or after a power break of more than 72 hours.

The controller has a 24 hour clock.

Aut. daylight (Daylight saving time changeover)

YES: The controller's built-in clock automatically changes + / - one hour on the standardized days for daylight saving time changeover for Central Europe.

NO: You change manually between summer and winter time by setting the clock backward or forward.



When controllers are connected as slaves in a master / slave system (via ECL 485 communication bus), they will receive 'Time & Date' from the master.

How to set time and date:

Action:	Purpose:	Examples:
	Choose 'MENU'	MENU
	Confirm	
	Choose the circuit selector at the top right corner in the display	
	Confirm	
	Choose 'Common controller settings'	
	Confirm	
	Go to 'Time & Date'	
	Confirm	
	Place the cursor at the position to be changed	
	Confirm	
	Enter the desired value	
	Confirm	
	Move the cursor to the next position to be changed. Continue until 'Time & Date' has been set.	
	Finally move the cursor to 'MENU'	
	Confirm	
	Move the cursor to 'HOME'	
	Confirm	

Operating Guide ECL Comfort 210 / 296 / 310, application A266

6.3 Holiday

This section describes the function in general for the ECL Comfort 210 / 296 / 310 series. The shown displays are typical and not application related. They might differ from the displays in your application.

There is a holiday program for each circuit and a holiday program for the common controller.

Each holiday program contains one or more schedules. Each schedule can be set to a start date and an end date. The set period starts on the start date at 00.00 and stops on the end date at 00.00.

Selectable modes are Comfort, Saving, Frost protection or Comfort 7-23 (before 7 and after 23, the mode is scheduled).

How to set your holiday schedule:

Action:	Purpose:	Examples:
	Choose 'MENU'	MENU
	Confirm	
	Choose the circuit selector at the top right corner in the display	
	Confirm	
	Choose a circuit or 'Common controller settings'	
	Heating	
	DHW	
	Common controller settings	
	Confirm	
	Go to 'Holiday'	
	Confirm	
	Choose a schedule	
	Confirm	
	Confirm choice of mode selector	
	Choose mode	
	· Comfort	
	· Comfort 7-23	
	· Saving	
	· Frost protection	
	Confirm	
	Enter the start time first and then the end time	
	Confirm	
	Go to 'Menu'	
	Confirm	
	Choose 'Yes' or 'No' in 'Save'. Choose the next schedule, if required	

The holiday program in the 'Common controller settings' is valid for all circuits. The holiday program can also be set individually in the heating or DHW circuits.

The end date must be at least be one day later than the start date.

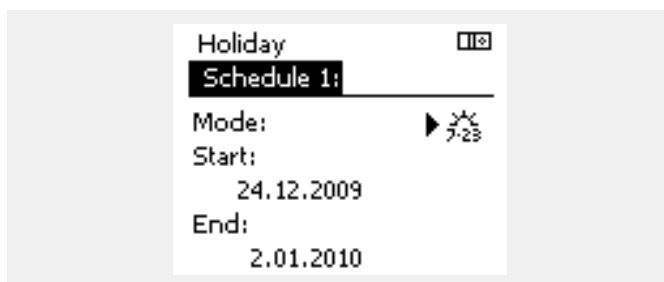
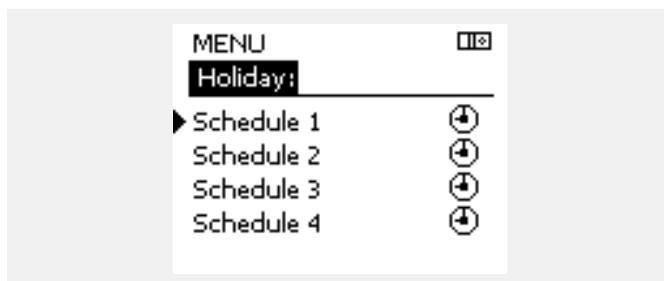

Operating Guide ECL Comfort 210 / 296 / 310, application A266

Holiday, specific circuit / Common Controller

When setting one holiday program in specific circuit and another holiday program in Common Controller, a priority will be taken into account:





1. Comfort
2. Comfort 7 - 23
3. Saving
4. Frost protection

Holiday, deleting a set period:

- Choose the Schedule in question
- Change the mode to "Clock"
- Confirm

The ECA 30 / 31 cannot override the holiday schedule of the controller temporarily.

However, it is possible to make use of the following options from the ECA 30 / 31 when the controller is in scheduled mode:

-  Day off
-  Holiday
-  Relaxing (extended comfort period)
-  Going out (extended saving period)

Example 1:

Circuit 1:
Holiday set to "Saving"

Common Controller:
Holiday set to "Comfort"

Result:
As long as "Comfort" is active in Common Controller, circuit 1 will be in "Comfort".

Example 2:

Circuit 1:
Holiday set to "Comfort"

Common Controller:
Holiday set to "Saving"

Result:
As long as "Comfort" is active in circuit 1, it will be in "Comfort".

Example 3:

Circuit 1:
Holiday set to "Frost protection"

Common Controller:
Holiday set to "Saving"

Result:
As long as "Saving" is active in Common Controller, circuit 1 will be in "Saving".



Energy-saving trick:
Use 'Going out' (the extended saving period) for airing purposes (e.g. for ventilating the rooms by means of fresh air from open windows).



Connections and setup procedures for ECA 30 / 31:
See section 'Miscellaneous'.



Quick guide "ECA 30 / 31 to override mode":

1. Go to ECA MENU
2. Move cursor to "Clock" symbol
3. Select the "Clock" symbol
4. Choose and select one of 4 override functions
5. Below the override symbol: Set hours or date
6. Below hours / date: Set desired room temperature for the override period

6.4 Input overview

This section describes the function in general for the ECL Comfort 210 / 296 / 310 series. The shown displays are typical and not application related. They might differ from the displays in your application.

The input overview is located in the common controller settings.

This overview will always show you the actual temperatures in the system (read-only).

MENU ⏏	
Input overview:	
▶ Outdoor T	7.0 °C
Outdoor acc. T	5.8 °C
Heat return T	35.5 °C
Heat flow T	67.9 °C
DHW flow T	68.6 °C



"Outdoor acc. T" means "Accumulated outdoor temperature" and is a calculated value in the ECL Comfort controller.

6.5 Log

This section describes the function in general for the ECL Comfort 210 / 296 / 310 series. The shown displays are typical and not application related. They might differ from the displays in your application.

The log function (temperature history) allows you to monitor the logs of today, yesterday, the past 2 days as well as the past 4 days for the connected sensors.

There is a log display for the relevant sensor, showing the measured temperature.

The log function is only available in the 'Common controller settings'.

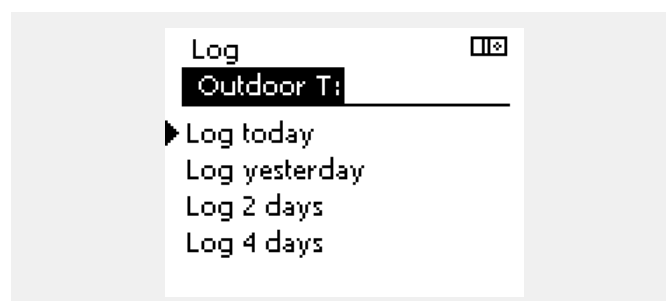
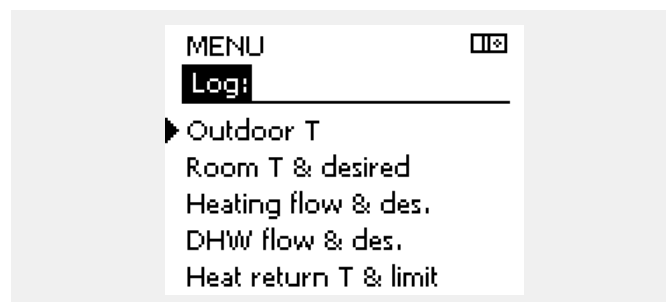

Example 1:
 1 day log for yesterday showing the development in outdoor temperature during the past 24 hours.

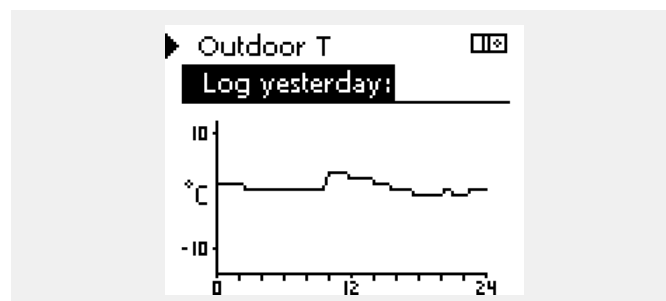

Example 2:
 Today's log for the actual heating flow temperature as well as the desired temperature.

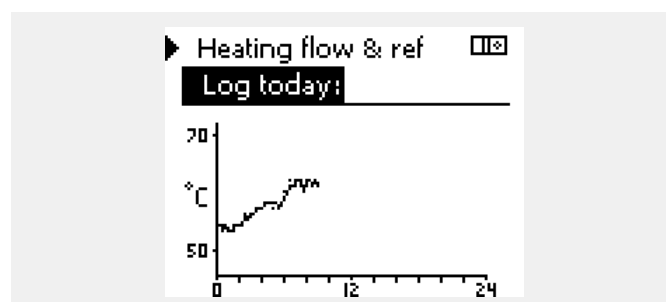

Example 3:
 Yesterday's log for the DHW flow temperature as well as the desired temperature.

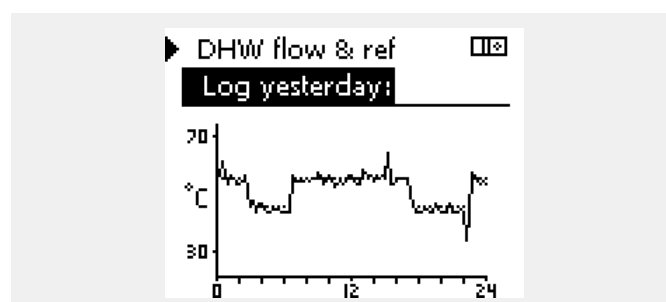

Operating Guide ECL Comfort 210 / 296 / 310, application A266

6.6 Output override

This section describes the function in general for the ECL Comfort 210 / 296 / 310 series. The shown displays are typical and not application related. They might differ from the displays in your application.

The output override is used to disable one or more of the controlled components. This could among others be useful in a service situation.

Action:	Purpose:	Examples:
	Choose 'MENU' in any of the overview displays	MENU
	Confirm	
	Choose the circuit selector at the top right corner in the display	
	Confirm	
	Choose common controller settings	
	Confirm	
	Choose 'Output override'	
	Confirm	
	Choose a controlled component	M1, P1 etc.
	Confirm	
	Adjust the status of the controlled component: Motorized control valve: AUTO, STOP, CLOSE, OPEN Pump: AUTO, OFF, ON	
	Confirm status change	

Remember to change the status back again as soon as an override is not required any longer.

Controlled components	Circuit selector
MENU	
Output override:	
▶ M1	AUTO
P1	AUTO
M2	OPEN
P2	AUTO
A1	AUTO



"Manual control" has higher priority than "Output override".



When the selected controlled component (output) is not 'AUTO', the ECL Comfort controller does not control the component in question (pump or motorized control valve e.g.). Frost protection is not active.



When output override of a controlled component is active the symbol '!' is shown to the right of the mode indicator in the enduser displays.



The motorized control valves M1 and M2 are controlled by 0–10 volt (0–100%) signals. Each of them can be set to AUTO or ON.

AUTO: Normal control (0–100%)

ON: The 0–10 volt signal is set to the %-value, set below the indication 'ON'.

6.7 Key functions

New application	<p>Erase application: Removes the existing application. As soon as the ECL key is inserted, another application can be chosen.</p>
Application	<p>Gives an overview over the actual application in the ECL controller. Push the dial again to exit the overview.</p>
Factory setting	<p>System settings: System settings are, among others, communication set-up, display brightness etc.</p> <p>User settings: User settings are, among others, desired room temperature, desired DHW temperature, schedules, heat curve, limitation values etc.</p> <p>Go to factory: Restores the factory settings.</p>
Copy	<p>To: Copy direction</p> <p>System settings</p> <p>User settings</p> <p>Start copying</p>
Key overview	<p>Gives an overview over the inserted ECL key. (Example: A266 Ver. 2.30). Turn the dial to see the subtypes. Push the dial again to exit the overview.</p>

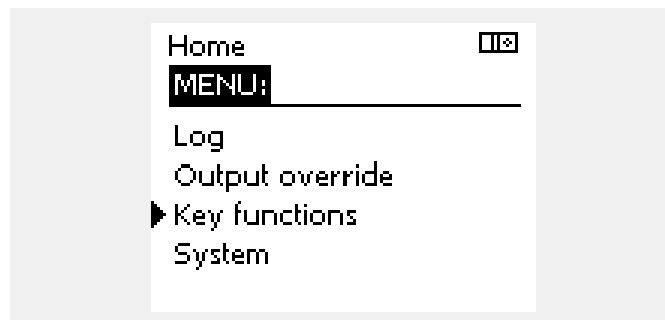

A more detailed description of how to use the individual 'Key functions' can also be seen in 'Inserting the ECL application key'.



The "Key overview" does not inform — through ECA 30 / 31 — about the subtypes of the application key.



Key inserted / not inserted, description:

ECL Comfort 210 / 310, controller versions lower than 1.36:

- Take out the application key; for 20 minutes settings can be changed.
- Power up the controller **without** the application key inserted; for 20 minutes settings can be changed.

ECL Comfort 210 / 310, controller versions 1.36 and up:

- Take out the application key; for 20 minutes settings can be changed.
- Power up the controller **without** the application key inserted; settings cannot be changed.

ECL Comfort 296 , controller versions 1.58 and up:

- Take out the application key; for 20 minutes settings can be changed.
- Power up the controller **without** the application key inserted; settings cannot be changed.

Operating Guide ECL Comfort 210 / 296 / 310, application A266

6.8 System

6.8.1 ECL version

In 'ECL version' you will always be able to find an overview of the data related to your electronic controller.

Please have this information available if you need to contact your Danfoss sales organization concerning the controller.

Information about your ECL Application Key can be found in 'Key functions' and 'Key overview'.

Code no.:	The Danfoss sales and order no. for the controller
Hardware:	Hardware version of the controller
Software:	Software (firmware) version of the controller
Serial no.:	Unique number for the individual controller
Production week:	Week no. and year (WW.YYYY)

Example, ECL version

System	☐☒
ECL version:	
▶ Code no.	087H3040
Hardware	B
Software	10.50
Build no.	7475
Serial no.	5335

6.8.2 Extension

ECL Comfort 310 / 310B:
'Extension' will offer you information about additional modules, if any. An example could be the ECA 32 module.

6.8.3 Ethernet

ECL Comfort 296 / 310 / 310B have a Modbus/TCP communication interface that allows the ECL controller to be connected to an Ethernet network. This allows remote access to the ECL 296 / 310 / 310B controller based on standard communication infrastructures.

In 'Ethernet' it is possible to set up the required IP addresses.

6.8.4 Portal config

ECL Comfort 296 / 310 / 310B have a Modbus/TCP communication interface that allows the ECL controller to be monitored and controlled via the ECL Portal.

ECL Portal related parameters are set here.

Documentation for ECL Portal: See <https://ecl.portal.danfoss.com>

6.8.5 M-bus config

ECL Comfort 296 / 310 / 310B have an M-bus communication interface that allows energy meters to be connected as slaves.

M-bus related parameters are set here.

Operating Guide ECL Comfort 210 / 296 / 310, application A266

6.8.6 Energy meter and M-bus, general information

ECL Comfort 296 / 310 / 310B only

When using the Application Key in the ECL Comfort 296 / 310 / 310B, up to 5 energy meters can be connected to the M-bus connections.

Connection of energy meter can:

- limit the flow
- limit the power
- transfer energy meter data to the ECL Portal, via Ethernet, and / or a SCADA system, via Modbus.

Many applications with control of heating, DHW or cooling circuit have the possibility to react on energy meter data.

To verify if actual application key can be set to react on energy meter data:

See Circuit > MENU > Settings > Flow / power.

The ECL Comfort 296 / 310 / 310B can always be used for monitoring purpose of up to 5 energy meters.

The ECL Comfort 296 / 310 / 310B act as an M-bus master and must be set to communicate with connected energy meter(s).

See MENU > Common controller > System > M-bus config.

Technical info:

- The M-bus data are based on standard EN-1434.
- Danfoss recommends AC supplied energy meters in order to avoid battery draining.

MENU > Common controller > System > M-bus config.

State		Read-out
Circuit	Setting range	Factory setting
-	-	-
<i>Information about the current M-bus activity.</i>		

IDLE: Normal state

INIT: The command for initialization has been activated

SCAN: The command for scanning has been activated

GATEW: The command Gateway has been activated

MENU > Common controller > System > M-bus config.

Baud (bits per second)		5997
Circuit	Setting range	Factory setting
-	300 / 600 / 1200 / 2400	300
<i>The communication speed between ECL Comfort 296 / 310 / 310B and the connected energy meter(s).</i>		



Energy meter data acquisition from ECL Portal is possible without setting up the M-bus configuration.



The ECL Comfort 296 / 310 / 310B will return to IDLE when commands have been completed.
Gateway is used for read-out of energy meter via ECL Portal.



Typically, 300 or 2400 baud is used.
If ECL Comfort 296 / 310 / 310B are connected to the ECL Portal, a baud rate of 2400 is recommendable, provided the energy meter allows this.

Operating Guide ECL Comfort 210 / 296 / 310, application A266

MENU > Common controller > System > M-bus config.

Command		5998
Circuit	Setting range	Factory setting
-	NONE / INIT / SCAN / GATEW	NONE

The ECL Comfort 296/310/310B are M-bus masters. In order to verify connected energy meters, different commands can be activated.

NONE: No command activated

INIT: Initialization is activated

SCAN: Scanning is activated in order to search for connected energy meters. The ECL Comfort 296 / 310 / 310B detect the M-bus addresses of up to 5 connected energy meters and place these automatically in the "Energy meters" section. The verified address is placed after "Energy meter 1 (2, 3, 4, 5)"

GATEW: The ECL Comfort 296 / 310 / 310B act as a gateway between energy meters and ECL Portal. Used only for service.



Scan time can take up to 12 minutes.
When all energy meters are found, the command can be changed to INIT or NONE.

MENU > Common controller > System > M-bus config.

M-bus address Energy meter 1 (2, 3, 4, 5)		6000
Circuit	Setting range	Factory setting
-	0 - 255	255

The set or verified address of energy meter 1 (2, 3, 4, 5).

0: Normally not used

1 - 250: Valid M-bus addresses

251 - 254: Special functions. Use only M-bus address 254 when one energy meter is connected.

255: Not used

MENU > Common controller > System > M-bus config.

Type Energy meter 1 (2, 3, 4, 5)		6001
Circuit	Setting range	Factory setting
-	0 - 4	0

Selecting data range from the M-bus telegram..

0: Small data set, small units

1: Small data set, large units

2: Large data set, small units

3: Large data set, large units

4: Volume and energy data only
(example: HydroPort Pulse)



Data examples:

0:
Flow temp., return temp., flow, power, acc. volume, acc. energy.

3:
Flow temp., return temp., flow, power, acc. volume, acc. energy, tariff 1, tariff 2.

See also the "Instructions, ECL Comfort 210 / 310, communication description" for further details.

See also Appendix for detailed description of "Type".

Operating Guide ECL Comfort 210 / 296 / 310, application A266

MENU > Common controller > System > M-bus config.

Scan time		6002
Energy meter 1 (2, 3, 4, 5)		
Circuit	Setting range	Factory setting
-	1 - 3600 sec	60 sec
Setting the scanning time for acquiring data of connected energy meter(s).		



If the energy meter is battery powered, the scan time should be set to a high value to prevent a too fast battery draining. Oppositely, if the flow / power limitation function is used in the ECL Comfort 310, the scan time should be set to a low value in order to have quick limitation.

MENU > Common controller > System > M-bus config.

ID		Read-out
Energy meter 1 (2, 3, 4, 5)		
Circuit	Setting range	Factory setting
-	-	-
Information about the energy meter's serial no.		

MENU > Common controller > System > Energy meters

Energy meter 1 (2, 3, 4, 5)		Read-out
Circuit	Setting range	Factory setting
-	0 - 4	0
Information from actual energy meter about, for example, ID, temperatures, flow / volume, power / energy. The shown information depends on the settings made in the "M-bus config." menu.		

6.8.7 Raw input overview

Measured temperatures, input status and voltages are displayed.

In addition, a detection of malfunctions can be chosen for activated temperature inputs.

Monitoring the sensors:

Choose the sensor which measures a temperature, for example the S5. When the dial is pressed, a magnifying glass appears in the selected line. The S5 temperature is now being monitored.

Alarm indication:

Should the connection to the temperature sensor be disconnected, short-circuited or the sensor itself be defective, the alarm function is activated.

In the "Raw input overview" an alarm symbol is shown at the defective temperature sensor in question.

Resetting the alarm:

Choose the sensor (S number) for which you want to clear the alarm. Press the dial. The magnifying glass and alarm symbols disappear.

When the dial is pressed again, the monitoring function is reactivated.



The temperature sensor inputs have a measuring range from -60 ... 150 °C.

If a temperature sensor or its connection breaks, the value indication is "--".

If a temperature sensor or its connection is short-circuited, the value indication is "---".

Operating Guide ECL Comfort 210 / 296 / 310, application A266

6.8.8 Sensor offset (new functionality as from firmware 1.59)

The measured temperature can be offset adjusted in order to compensate for cable resistance or a not-optimum place for the temperature sensor. The adjusted temperature can be seen in "Raw input overview" and "Input overview".

Common controller > System > Sensor offset

Sensor 1 . . . (temperature sensor)		
Circuit	Setting range	Factory setting
□□○	*	*
Setting the offset of the measured temperature.		

Positive offset value: The temperature value is increased

Negative offset value:

The temperature value is decreased

offset value:

6.8.9 Display

Backlight (display brightness)		60058
Circuit	Setting range	Factory setting
□□○	0 ... 10	5
Adjust the brightness of the display.		

0: Weak backlight.

10: Strong backlight.

Contrast (display contrast)		60059
Circuit	Setting range	Factory setting
□□○	0 ... 10	3
Adjust the contrast of the display.		

0: Low contrast.

10: High contrast.

6.8.10 Communication

Modbus addr.		38
Circuit	Setting range	Factory setting
□□○	1 ... 247	1
Set the Modbus address if the controller is part of a Modbus network.		

1 ... 247: Assign the Modbus address within the stated setting range.

Operating Guide ECL Comfort 210 / 296 / 310, application A266

ECL 485 addr. (master / slave address)		2048
Circuit	Setting range	Factory setting
	0 ... 15	15

This setting is relevant if more controllers are working in the same ECL Comfort system (connected via the ECL 485 communication bus) and / or Remote Control Units (ECA 30 / 31) are connected.

- 0:** The controller works as slave.
The slave receives information about the outdoor temperature (S1), system time, and signal for DHW demand in the master.
- 1 ... 9:** The controller works as slave.
The slave receives information about the outdoor temperature (S1), system time, and signal for DHW demand in the master. The slave sends information about the desired flow temperature to the master.
- 10 ... 14:** Reserved.
- 15:** The ECL 485 communication bus is active.
The controller is master. The master sends information about the outdoor temperature (S1) and system time. Connected Remote Control Units (ECA 30 / 31) are powered.

The ECL Comfort controllers can be connected via the ECL 485 communication bus to perform a larger system (the ECL 485 communication bus can connect to max. 16 devices).

Each slave must be configured with its own address (1 ... 9).

However, more slaves can have the address 0 if they only have to receive information about outdoor temperature and system time (listeners).

Service Pin		2150
Circuit	Setting range	Factory setting
	0 / 1	0

This setting is only used in connection with set-up of Modbus communication.

Not applicable for the time being and reserved for future use!

Ext. reset		2151
Circuit	Setting range	Factory setting
	0 / 1	0

This setting is only used in connection with set-up of Modbus communication.

- 0:** Reset not activated.
- 1:** Reset.



The total cable length of max. 200 m (all devices incl. the internal ECL 485 communication bus) should not be exceeded.
Cable lengths of more than 200 m may cause noise sensibility (EMC).



In a system with MASTER / SLAVE controllers, only one MASTER controller with address 15 is allowed.

If by mistake more MASTER controllers are present in an ECL 485 communication bus system, decide which controller is to be MASTER. Change the address in the remaining controllers. However, the system will operate but not be stable with more than one MASTER controller.



In the MASTER controller, the address in 'ECL 485 addr. (master / slave address)', ID no. 2048, must always be 15.

6.8.11 Language

Language		2050
<i>Circuit</i>	<i>Setting range</i>	<i>Factory setting</i>
<input type="checkbox"/>	English / 'Local'	English
<i>Choose your language.</i>		



Local language is selected during installation. If you want to change to another local language, the application must be reinstalled. However, it is always possible to change between the local language and English.

Operating Guide ECL Comfort 210 / 296 / 310, application A266

7.0 Miscellaneous

7.1 ECA 30 / 31 setup procedures

ECA 30 (code no. 087H3200) is a remote control unit with built-in room temperature sensor.

ECA 31 (code no. 087H3201) is a remote control unit with built-in room temperature sensor and humidity sensor (relative humidity).

An external room temperature sensor can be connected to both types to substitute the built-in sensor.

An external room temperature sensor will be recognized at ECA 30 / 31 power-up.

Connections: See the section 'Electrical connections'.

Max. two ECA 30 / 31 can be connected to one ECL controller or a system (master-slave) consisting of several ECL controllers connected on the same ECL 485 bus. In the master-slave system only one of the ECL controllers is master. The ECA 30 / 31 can, among others, be set to:

- monitor and set the ECL controller remotely
- measure the room temperature and (ECA 31) humidity
- extend comfort / saving period temporarily

After application upload in the ECL Comfort controller, the remote control unit ECA 30 / 31 will after approx. one minute ask to 'Copy application'.

Confirm this in order to upload the application to the ECA 30 / 31.

Menu structure

The menu structure of ECA 30 / 31 is an "ECA MENU" and the ECL menu, copied from the ECL Comfort controller.

The ECA MENU contains:

- ECA settings
- ECA system
- ECA factory

ECA settings: Offset adjustment of the measured room temperature.

Offset adjustment of relative humidity (ECA 31 only).

ECA system: Display, communication, override settings and version info.

ECA factory: Erase of all applications in the ECA 30 / 31, restore to factory settings, reset of ECL address and firmware update.

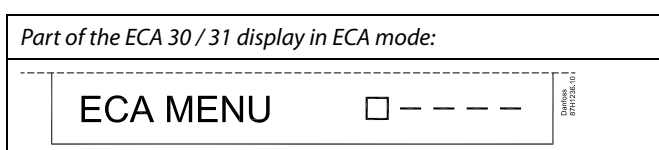
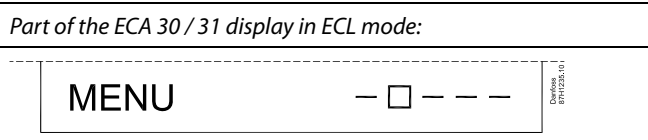

If only the "ECA MENU" is shown, it can indicate that the ECA 30 / 31 is not having correct communication address.
See ECA MENU > ECA system > ECA communication: ECL address.
In most cases the ECL address setting must be "15".



Regarding ECA settings:
When ECA 30 / 31 is not used as remote unit, the offset adjustments menu(s) are not present.

Operating Guide ECL Comfort 210 / 296 / 310, application A266

The ECL menus are as described for the ECL controller.

Most of the settings done directly in the ECL controller can be done via the ECA 30 / 31 too.



All settings can be seen even if the application key is not inserted in the ECL controller.
For changing settings, the application key must be inserted.

The Key overview (MENU > 'Common controller settings' > 'Key functions') does not show the applications of the key.



The ECA 30 / 31 will display this information (an X on the ECA 30 / 31 symbol) if the application in the ECL controller does not comply with the ECA 30 / 31:

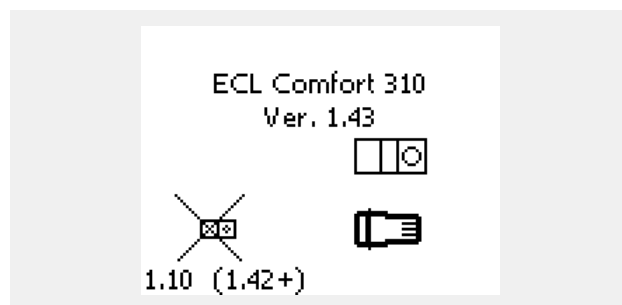

In the example 1.10 is current version and 1.42 is desired version.



Display part of ECA 30 / 31:

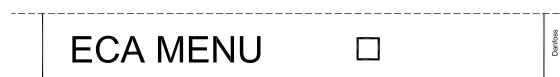

This display indicates that an application has not been uploaded or the communication to the ECL controller (master) is not working properly. An X on the ECL controller symbol indicates wrong setup of communication addresses.



Display part of ECA 30 / 31:



Newer versions of ECA 30 / 31 indicate the address number of the connected ECL Comfort controller.

Address number can be changed in the ECA MENU.

A stand-alone ECL Controller has the address 15.

Operating Guide ECL Comfort 210 / 296 / 310, application A266

When ECA 30 / 31 is in ECA MENU mode, the date and measured room temperature is displayed.

ECA MENU > ECA settings > ECA sensor

Room T Offset	
Setting range	Factory setting
-10.0 ... 10.0 K	0.0 K
<i>The measured room temperature can be corrected with a number of Kelvin. The corrected value is used by the heating circuit in the ECL controller.</i>	

Minus value: The indicated room temperature is lower.

0.0 K: No correction of the measured room temperature.

Plus value: The indicated room temperature is higher.

Example:	
Room T offset:	0.0 K
Displayed room temperature:	21.9 °C
Room T offset:	1.5 K
Displayed room temperature:	23.4 °C

ECA MENU > ECA settings > ECA sensor

RH offset (ECA 31 only)	
Setting range	Factory setting
-10.0 ... 10.0 %	0.0 %
<i>The measured relative humidity can be corrected with a number of %-values. The corrected value is used by the application in the ECL controller.</i>	

Minus value: The indicated relative humidity is lower.

0.0 %: No correction of the measured relative humidity.

Plus value: The indicated relative humidity is higher.

Example:	
RH offset:	0.0 %
Displayed relative humidity:	43.4 %
RH offset:	3.5 %
Displayed relative humidity:	46.9 %

ECA MENU > ECA system > ECA display

Backlight (display brightness)	
Setting range	Factory setting
0 ... 10	5
<i>Adjust the brightness of the display.</i>	

0: Weak backlight.

10: Strong backlight.

Operating Guide ECL Comfort 210 / 296 / 310, application A266

ECA MENU > ECA system > ECA display

Contrast (display contrast)	
Setting range	Factory setting
0 ... 10	3
<i>Adjust the contrast of the display.</i>	

- 0:** Low contrast.
10: High contrast.

ECA MENU > ECA system > ECA display

Use as remote	
Setting range	Factory setting
OFF / ON	*)
<i>ECA 30 / 31 can act as a simple or normal remote control for the ECL controller.</i>	

- OFF:** Simple remote control, no room temperature signal.
ON: Remote control, room temperature signal is available.
***):** Differently, depending on chosen application.



When set to OFF: The ECA menu shows date and time.

When set to ON: The ECA menu shows date and room temperature (and for ECA 31 relative humidity).

ECA MENU > ECA system > ECA communication

Slave addr. (Slave address)	
Setting range	Factory setting
A / B	A
<i>The setting of 'Slave addr.' is related to the setting 'ECA address' in the ECL controller. In the ECL controller it is selected from which ECA 30 / 31 unit the room temperature signal is received.</i>	

- A:** The ECA 30 / 31 has the address A.
B: The ECA 30 / 31 has the address B.



For installation of an application in an ECL Comfort 210 / 296 / 310 controller the 'Slave addr.' must be A.



If two ECA 30 / 31 are connected in the same ECL 485 bus system, the 'Slave addr.' must be "A" in the one ECA 30 / 31 unit and "B" in the other.

Operating Guide ECL Comfort 210 / 296 / 310, application A266

ECA MENU > ECA system > ECA communication

Connection addr. (Connection address)	
Setting range	Factory setting
1 ... 9 / 15	15
Setting of the address to which ECL controller the communication must run.	

1 .. 9: Slave controllers.

15: Master controller.



An ECA 30 / 31 can in an ECL 485 bus system (master – slave) be set to communicate, one by one, with all addressed ECL controllers.



Example:

Connection addr. = 15:	The ECA 30 / 31 communicates with the ECL master controller.
Connection addr. = 2:	The ECA 30 / 31 communicates with the ECL controller with address 2.



There must be a master controller present in order to broadcast time and date information.



An ECL Comfort controller 210 / 310, type B (without display and dial) cannot be assigned to the address 0 (zero).

ECA MENU > ECA system > ECA override

Override addr. (Override address)	
Setting range	Factory setting
OFF / 1 ... 9 / 15	OFF
The feature 'Override' (to extended comfort or saving period or holiday) must be addressed to the ECL controller in question.	

OFF: Override not possible.

1 .. 9: Address of slave controller for override.

15: Address of master controller for override.



Override functions:	Extended saving mode:	
	Extended comfort mode:	
	Holiday away from home:	
	Holiday at home:	



Override by means of settings in ECA 30 / 31 are cancelled if the ECL Comfort controller goes into holiday mode or is changed to another mode than scheduled mode.



The circuit in question for override in the ECL controller must be in scheduled mode.
See also the parameter 'Override circuit'.

Operating Guide ECL Comfort 210 / 296 / 310, application A266

ECA MENU > ECA system > ECA override

Override circuit	
Setting range	Factory setting
OFF / 1 ... 4	OFF
<i>The feature 'Override' (to extended comfort or saving period or holiday) must be addressed to the heating circuit in question.</i>	

OFF: No heating circuit is selected for override.

1 ... 4: The heating circuit number in question.



The circuit in question for override in the ECL controller must be in scheduled mode.
See also the parameter 'Override addr.'.



Example 1:

(One ECL controller and one ECA 30 / 31)		
Override of heating circuit 2:	Set 'Connection addr.' to 15	Set 'Override circuit' to 2

Example 2:

(Several ECL controllers and one ECA 30 / 31)		
Override of heating circuit 1 in ECL controller with the address 6:	Set 'Connection addr.' to 6	Set 'Override circuit' to 1



Quick guide "ECA 30 / 31 to override mode":

1. Go to ECA MENU
2. Move cursor to "Clock" symbol
3. Select the "Clock" symbol
4. Choose and select one of 4 override functions
5. Below the override symbol: Set hours or date
6. Below hours / date: Set desired room temperature for the override period

ECA MENU > ECA system > ECA version

ECA version (read-out only), examples	
Code no.	087H3200
Hardware	A
Software	1.42
Build no.	5927
Serial no.	13579
Production week	23.2012



ECA 30 / 31:

15	Connection address (master: 15, slaves: 1 - 9)
----	--

The ECA version information is useful in service situations.

Operating Guide ECL Comfort 210 / 296 / 310, application A266

ECA MENU > ECA factory > ECA clear apps.

Erase all apps. (Erase all applications)

*Erase all applications which are in the ECA 30 / 31.
After erasing, the application can be uploaded again.*

NO: The erase procedure is not done.

YES: The erase procedure is done (await 5 sec.).



After the erase procedure, a pop-up in the display indicates "Copy application". Choose "Yes". Hereafter the application is uploaded from the ECL controller. An upload bar is shown.

ECA MENU > ECA factory > ECA default

Restore factory

The ECA 30 / 31 is set back to factory settings.

Affected settings by the restore procedure:

- Room T offset
- RH offset (ECA 31)
- Backlight
- Contrast
- Use as remote
- Slave addr.
- Connection addr.
- Override addr.
- Override circuit
- Override mode
- Override mode end time

NO: The restore procedure is not done.

YES: The restore procedure is done.

Operating Guide ECL Comfort 210 / 296 / 310, application A266

ECA MENU > ECA factory > Reset ECL addr.

Reset ECL addr. (Reset ECL address)

If none of the connected ECL Comfort controllers has the address 15, the ECA 30 / 31 can set all connected ECL controllers on the ECL 485 bus back to address 15.

NO: The reset procedure is not done.

YES: The reset procedure is done (await 10 sec.).



The ECL 485 bus related address of the ECL controller is found:
MENU > 'Common controller settings' > 'System' > 'Communication' > 'ECL 485 addr.'



The "Reset ECL addr." cannot be activated if one or more of the connected ECL Comfort controllers has the address 15.



In a system with MASTER / SLAVE controllers, only one MASTER controller with address 15 is allowed.

If by mistake more MASTER controllers are present in an ECL 485 communication bus system, decide which controller is to be MASTER. Change the address in the remaining controllers. However, the system will operate but not be stable with more than one MASTER controller.

ECA MENU > ECA factory > Update firmware

Update firmware

The ECA 30 / 31 can be updated with new firmware (software). The firmware comes with the ECL application key, when the key version is at least 2.xx. If no new firmware is available, a symbol of the application key is displayed with an X.

NO: The updating procedure is not done.

YES: The updating procedure is done.



The ECA 30 / 31 automatically verifies if a new firmware is present on the application key in the ECL Comfort controller. The ECA 30 / 31 is automatically updated at new application upload in the ECL Comfort controller.

The ECA 30 / 31 is not automatically updated when connected to an ECL Comfort controller with uploaded application. A manual update is always possible.



Quick guide "ECA 30 / 31 to override mode":

1. Go to ECA MENU
2. Move cursor to "Clock" symbol
3. Select the "Clock" symbol
4. Choose and select one of 4 override functions
5. Below the override symbol: Set hours or date
6. Below hours / date: Set desired room temperature for the override period

Operating Guide ECL Comfort 210 / 296 / 310, application A266

7.2 Override function

The ECL 210 / 296 / 310 controllers can receive a signal in order to override the existing schedule. The override signal can be a switch or a relay contact.

Different override modes can be selected, depending on application key type.

Override modes: Comfort, Saving, Constant temperature and Frost protection.

"Comfort" is also called normal heating temperature.

"Saving" can be reduced heating or heating stopped.

"Constant temperature" is a desired flow temperature, set in the menu "Flow temperature".

"Frost protection" stops the heating totally.

Override by means of override switch or relay contact is possible when the ECL 210 / 296 / 310 is in scheduled mode (clock).

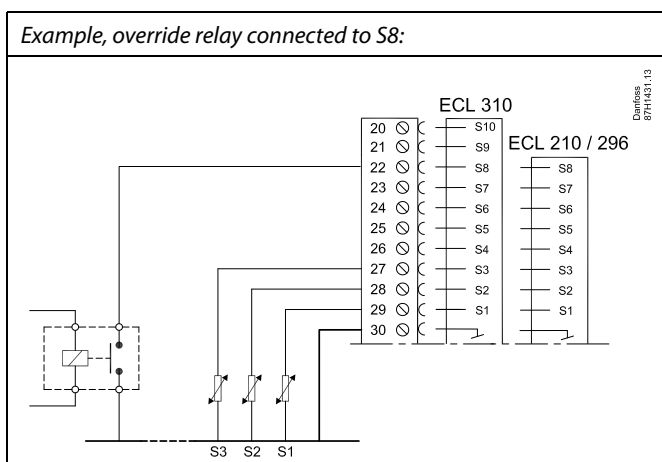
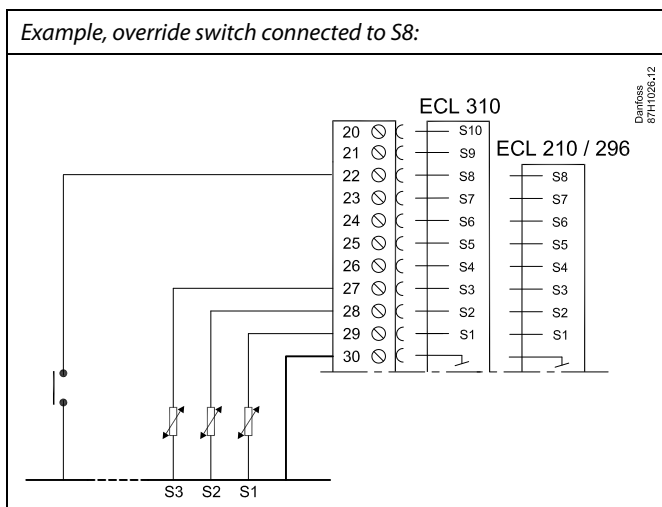

Operating Guide ECL Comfort 210 / 296 / 310, application A266

Example 1

ECL in Saving mode, but in Comfort mode at override.

Choose an unused input, for example S8. Connect the override switch or override relay contact.

Settings in ECL:

1. Select circuit > MENU > Settings > Application > Ext. input:
Select the input S8 (the wiring example)
2. Select circuit > MENU > Settings > Application > Ext. mode:
Select COMFORT
3. Select circuit > MENU > Schedule:
Select all weekdays
Set "Start1" to 24.00 (this disables Comfort mode)
Exit menu and confirm by "Save"
4. Remember to set the circuit in question in scheduled mode ("clock").

Result: When the override switch (or the relay contact) is ON, the ECL 210 / 296 / 310 will operate in Comfort mode.

When the override switch (or the relay contact) is OFF, the ECL 210 / 296 / 310 will operate in Saving mode.

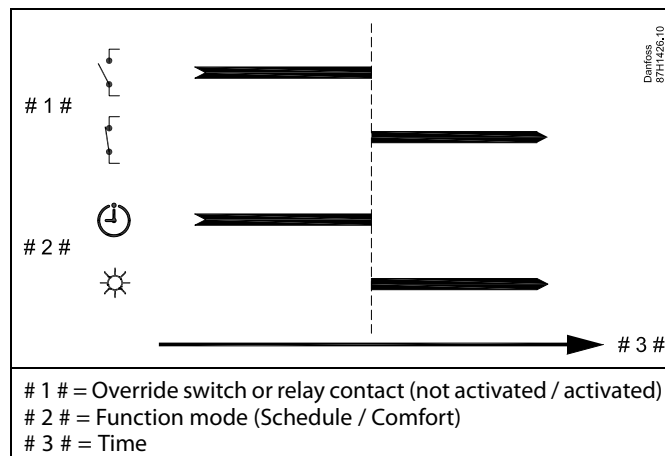

Example 2

ECL in Comfort mode, but in Saving mode at override.

Choose an unused input, for example S8. Connect the override switch or override relay contact.

Settings in ECL:

1. Select circuit > MENU > Settings > Application > Ext. input:
Select the input S8 (the wiring example)
2. Select circuit > MENU > Settings > Application > Ext. mode:
Select SAVING
3. Select circuit > MENU > Schedule:
Select all weekdays
Set "Start1" to 00.00
Set "Stop1" to 24.00
Exit menu and confirm by "Save"
4. Remember to set the circuit in question in scheduled mode ("clock").

Result: When the override switch (or the relay contact) is ON, the ECL 210 / 296 / 310 will operate in Saving mode.

When the override switch (or the relay contact) is OFF, the ECL 210 / 296 / 310 will operate in Comfort mode.

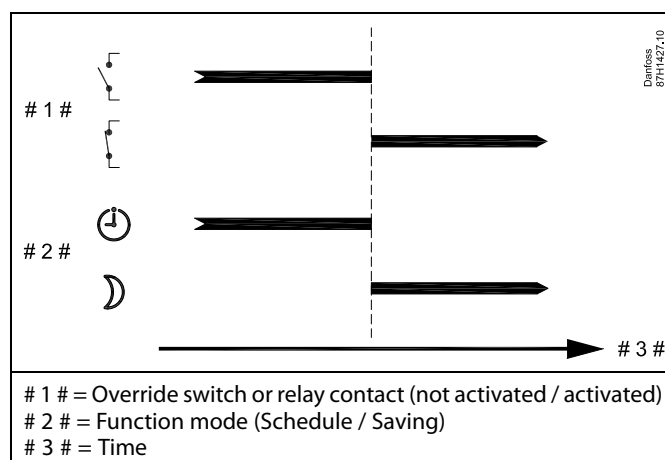

Operating Guide ECL Comfort 210 / 296 / 310, application A266

Example 3

The week schedule for the building is set with comfort periods Monday - Friday: 07.00 - 17.30. Sometimes, a team meeting takes place in the evening or in the week-end.

An override switch is installed and heating must be ON (Comfort mode) as long as the switch is ON.

Choose an unused input, for example S8. Connect the override switch.

Settings in ECL:

1. Select circuit > MENU > Settings > Application > Ext. input:
Select the input S8 (the wiring example)
2. Select circuit > MENU > Settings > Application > Ext. mode:
Select COMFORT
3. Remember to set the circuit in question in scheduled mode ("clock").

Result: When the override switch (or a relay contact) is ON, the ECL 210 / 296 / 310 will operate in Comfort mode.

When the override switch is OFF, the ECL 210 / 296 / 310 will operate according to the schedule.

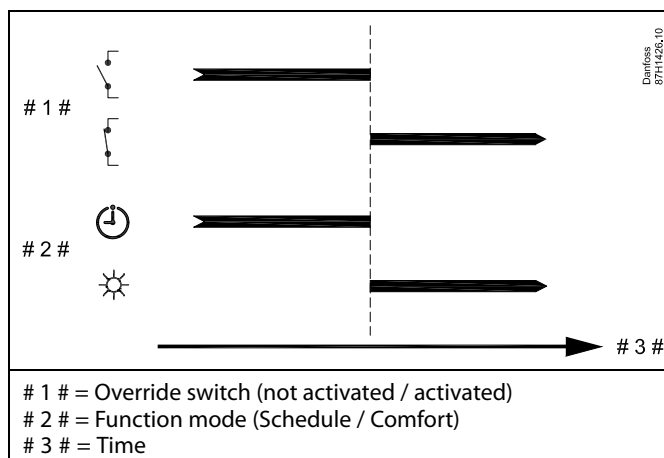

Example 4

The week schedule for the building is set with comfort periods all weekdays: 06.00 - 20.00. Sometimes, the desired flow temperature must be constant on 65 °C.

An override relay is installed and the flow temperature must be 65 °C as long as the override relay is activated.

Choose an unused input, for example S8. Connect the contacts of the override relay.

Settings in ECL:

1. Select circuit > MENU > Settings > Application > Ext. input:
Select the input S8 (the wiring example)
2. Select circuit > MENU > Settings > Application > Ext. mode:
Select CONST. T
3. Select circuit > MENU > Settings > Flow temperature >
Desired T (ID 1x004):
Set to 65 °C
4. Remember to set the circuit in question in scheduled mode ("clock").

Result: When the override relay is activated, the ECL 210 / 296 / 310 will operate in Const. temp. mode and control a flow temperature of 65 °C.

When the override relay is not activated, the ECL 210 / 296 / 310 will operate according to the schedule.

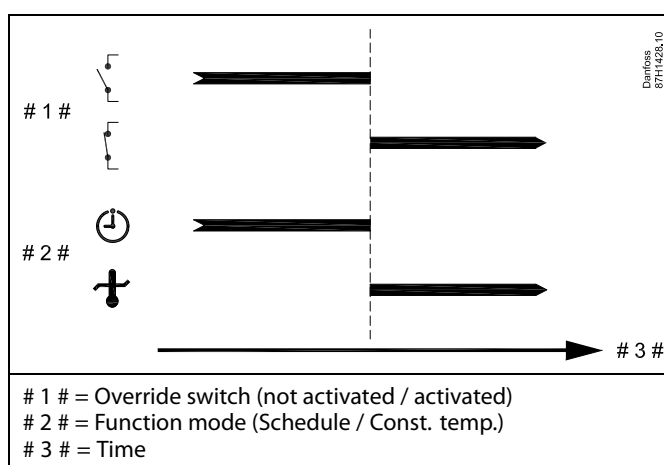

Operating Guide ECL Comfort 210 / 296 / 310, application A266

7.3 Several controllers in the same system

When ECL Comfort controllers are interconnected by means of the ECL 485 communication bus (cable type: 2 x twisted pair), the master controller will broadcast the following signals to the slave controllers:

- Outdoor temperature (measured by S1)
- Time and date
- DHW tank heating / charging activity

Furthermore, the master controller can receive information about:

- the desired flow temperature (demand) from slave controllers
- and (as from ECL controller version 1.48) DHW tank heating / charging activity in slave controllers

Situation 1:

SLAVE controllers: How to make use of the outdoor temperature signal sent from the MASTER controller

The slave controllers only receive information about outdoor temperature and date / time.

SLAVE controllers:

Change the factory set address from 15 to address 0.

- In go to System > Communication > ECL 485 addr.

ECL 485 addr. (master / slave address)		2048
Circuit	Setting range	Choose
<input type="text"/>	0 ... 15	0

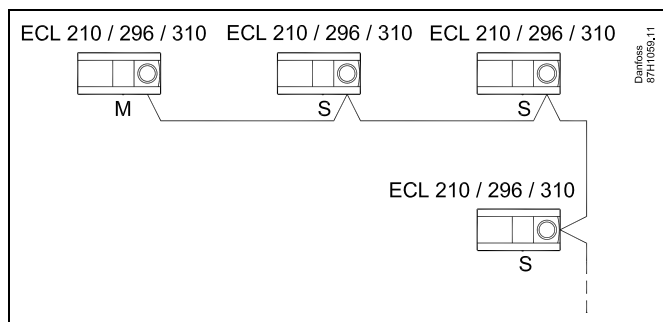

ECL 485 bus cable

Maximum recommended length of the ECL 485 bus is calculated like this:

Subtract "Total length of all input cables of all ECL controllers in the master - slave system" from 200 m.

Simple example for total length of all input cables, 3 x ECL:

1 x ECL	Outdoor temp. sensor:	15 m
3 x ECL	Flow temp. sensor:	18 m
3 x ECL	Return temp. sensor:	18 m
3 x ECL	Room temp. sensor:	30 m
Total:		81 m

Maximum recommended length of the ECL 485 bus:
200 - 81 m = 119 m



In a system with MASTER / SLAVE controllers, only one MASTER controller with address 15 is allowed.

If by mistake more MASTER controllers are present in an ECL 485 communication bus system, decide which controller is to be MASTER. Change the address in the remaining controllers. However, the system will operate but not be stable with more than one MASTER controller.



In the MASTER controller, the address in 'ECL 485 addr. (master / slave address)'; ID no. 2048, must always be 15.
Navigation:

- In go to System > Communication > ECL 485 addr.

SLAVE controllers must be set to another address than 15:
Navigation:

- In go to System > Communication > ECL 485 addr.



'Demand offset' with a value is to be used in the Master controller only.

Operating Guide ECL Comfort 210 / 296 / 310, application A266

Situation 2:

SLAVE controller: How to react on a DHW tank heating / charging activity sent from the MASTER controller

The slave receives information about a DHW tank heating / charging activity in the master controller and can be set to close the selected heating circuit.

ECL controller versions 1.48 (as from August 2013):

The master receives information about DHW tank heating / charging activity in the master controller itself and also slaves in the system.

This status is broadcasted to all ECL controllers in the system and each heating circuit can be set to close the heating.

SLAVE controller:

Set the desired function:

- In circuit 1 / circuit 2, go to 'Settings' > 'Application' > 'DHW priority':

DHW priority (closed valve / normal operation)		11052 / 12052
Circuit	Setting range	Choose
1 / 2	OFF / ON	OFF / ON

OFF: The flow temperature control remains unchanged during active DHW heating / charging in the master / slave system.

ON: The valve in the heating circuit is closed during active DHW heating / charging in the master / slave system.

Operating Guide ECL Comfort 210 / 296 / 310, application A266

Situation 3:

SLAVE controller: How to make use of the outdoor temperature signal and send information about the desired flow temperature back to the MASTER controller



In the MASTER controller, the address in 'ECL 485 addr. (master / slave address)'; ID no. 2048, must always be 15.

The slave controller receives information about outdoor temperature and date / time. The master controller receives information about the desired flow temperature from slave controllers with an address from 1 ... 9:

SLAVE controller:

- In , go to System > Communication > ECL 485 addr.
- Change the factory set address from 15 to an address (1 ... 9). Each slave must be configured with its own address.

ECL 485 addr. (master / slave address)		2048
Circuit	Setting range	Choose
<input type="checkbox"/>	0 ... 15	1 ... 9

Furthermore, each slave can send information about the desired flow temperature (demand) in each circuit back to the master controller.

SLAVE controller:

- In the circuit in question, go to Settings > Application > Send desired T
- Choose ON or OFF.

Send desired T		11500 / 12500
Circuit	Setting range	Choose
1 / 2	OFF / ON	ON or OFF

OFF: Information about the desired flow temperature is not sent to the master controller.

ON: Information about the desired flow temperature is sent to the master controller.

7.4 Frequently asked questions



The definitions apply to the ECL Comfort 210 / 296 / 310 series. Consequently, you might come across expressions that are not mentioned in your guide.

Circulation pump (heating) does not stop as expected

It is in operation at frost protection (outdoor temperature lower than "P frost T" value) and at heat demand (desired flow temperature higher than "P heat T" value)

The time shown in the display is one hour off?

See 'Time and Date'.

The time shown in the display is not correct?

The internal clock may have been reset, if there has been a power break for more than 72 hours.

Go to the 'Common controller settings' and 'Time & Date' to set the correct time.

The ECL Application Key is lost?

Switch the power off and on again to see the ECL controller type, version code (e.g. 1.52), code no. and application (e.g. A266.1) or go to 'Common controller settings' > 'Key functions' > 'Application'. The system type (e.g. TYPE A266.1) and the system diagram is displayed.

Order a replacement from your Danfoss representative (e.g. ECL Application Key A266).

Insert the new ECL Application Key and copy your personal settings from the controller to the new ECL Application Key, if required.

The room temperature is too low?

Make sure that the radiator thermostat does not limit the room temperature.

If you still cannot obtain the desired room temperature by adjusting the radiator thermostats, the flow temperature is too low. Increase the desired room temperature (display with desired room temperature). If this does not help, adjust the 'Heat curve' ('Flow temp').

The room temperature is too high during saving periods?

Make sure that the min. flow temperature limitation ('Temp. min.') is not too high.

The temperature is unstable?

Check that the flow temperature sensor is correctly connected and in the right place. Adjust the control parameters ('Control par').

If the controller has a room temperature signal, see 'Room limit'.

The controller does not operate and the control valve is closed?

Check that the flow temperature sensor is measuring the correct value, see 'Daily use' or 'Input overview'.

Check the influence from other measured temperatures.

How to make an extra comfort period in the schedule?

You can set an additional comfort period by adding new 'Start' and 'Stop' times in 'Schedule'.

How to remove a comfort period in the schedule?

You can remove a comfort period by setting start and stop times to the same value.

How to restore your personal settings?

Please read the chapter concerning 'Inserting the ECL Application Key'.

How to restore the factory settings?

Please read the chapter concerning 'Inserting the ECL Application Key'.

Why can't the settings be changed?

The ECL Application Key has been removed.

Why can't an application be selected when inserting the ECL application key into the controller?

The actual application in the ECL Comfort controller must be deleted before a new application (subtype) can be selected.

How to react on alarms?

An alarm indicates that the system is not operating satisfactorily. Please contact your installer.

What does P and PI control mean?

P control: Proportional control.

By using a P control, the controller will change the flow temperature proportional to the difference between a desired and an actual temperature, e.g. a room temperature.

A P control will always have an offset which not will disappear over time.

PI control: Proportional and Integrating control.

A PI control does the same as a P control, but the offset will disappear over time.

A long 'Tn' will give a slow but stable control, and a short 'Tn' will result in a fast control but with a higher risk of instability.

What does the "i" in the upper right corner of the display mean?

When uploading an application (subtype) from the application key into the ECL Comfort controller, the "i" in the upper right corner indicates that - besides the factory settings - the subtype also contains special user / systems settings.

Why can't the ECL 485 Bus (used in ECL 210 / 296 / 310) and the ECL Bus (used in ECL 100 / 110 / 200 / 300) communicate?

These two communication busses (Danfoss proprietary) are different in connection form, telegram form and speed.

Why can't I select a language when uploading an application?

Reason can be that the ECL 310 is powered with 24 Volt d.c.

Language

At application upload, a language must be selected.*

If another language than English is selected, the selected language

AND English will be uploaded into the ECL controller.

This makes service easy for English speaking service people, just because the English language menus can be visible by changing the actual set language into English.

(Navigation: MENU > Common controller > System > Language)

If the uploaded language is not suitable, the application must be erased. User and System settings can be saved on the application key before erasing.

After new upload with preferred language, the existing User and System settings can be uploaded.

*)

(ECL Comfort 310, 24 Volt) If language cannot be selected, the power supply is not a.c. (alternating current).

How to set a correct heat curve?

Short answer:

Set the heat curve to the lowest possible value, but still having comfortable room temperature.

The table shows some recommendations:

House with radiators:	Needed flow temp. when the outdoor temp. is -10 °C:	Recommended heat curve value:
Older than 20 years:	65 °C	1.4
Between 10 and 20 years old:	60 °C	1.2
Rather new:	50 °C	0.8
Floor heating systems need, in general, a lower heat curve value		

Technical answer:

In order to save energy, the flow temperature should be as low as possible, but still considering a comfortable room temperature. This means the heat curve slope should have a low value.

See the heat curve slope diagram.

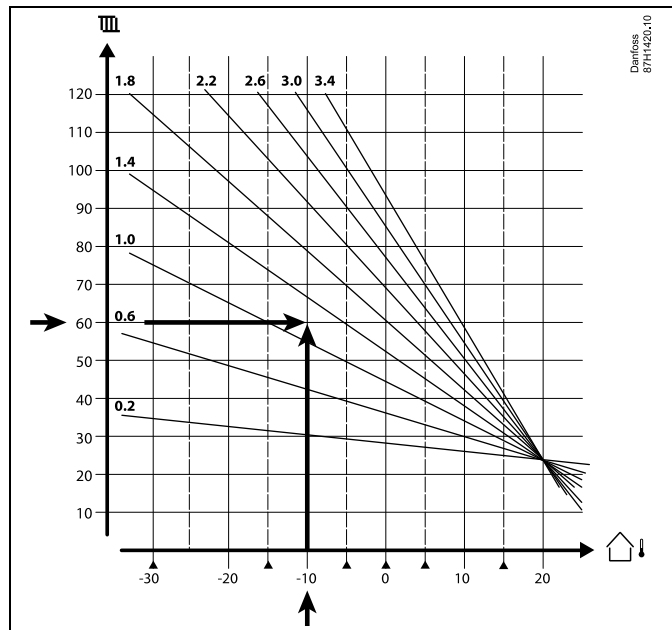

Choose the desired flow temperature (vertical axis) for your heating system at the expected lowest outdoor temperature (horizontal axis) for your area. Pick the heat curve closest to the common point of these two values.

Example: Desired flow temperature: 60 (°C) at outdoor temperature: -10 (°C)

Result: Heat curve slope value = 1.2 (mid-way between 1.4 and 1.0).

In general:

- Smaller radiators in your heating system might require a higher heat curve slope. (Example: Desired flow temperature 70 °C resulting in heat curve = 1.5).
- Floor heating systems require a lower heat curve slope. (Example: Desired flow temperature 35 °C resulting in heat curve = 0.4).
- Corrections of the heat curve slope should be done in small steps when having outdoor temperatures below 0 °C; one step pr. day.
- If required, adjust the heat curve in the six coordinate points.
- Setting of the desired **room** temperature has an influence on the desired flow temperature even if a room temperature sensor / Remote Control Unit is not connected. An example: Increasing the desired **room** temperature results in a higher flow temperature.
- Typically, the desired **room** temperature should be adjusted when having outdoor temperatures above 0 °C.

7.5 Definitions



The definitions apply to the ECL Comfort 210 / 296 / 310 series. Consequently, you might come across expressions that are not mentioned in your guide.

Accumulated temperature value

A filtered (dampened) value, typically for room and outdoor temperatures. Is calculated in the ECL controller and is used to express the heat stored in the walls of the house. The accumulated value does not change so rapidly as the actual temperature.

Air duct temperature

Temperature measured in the air duct where the temperature is to be controlled.

Alarm function

Based on the alarm settings, the controller can activate an output.

Anti-bacteria function

For a defined period, the DHW temperature is increased in order to neutralize dangerous bacteria, e.g. Legionella.

Balance temperature

This setpoint is the basis for the flow / air duct temperature. The balance temperature can be adjusted by the room temperature, the compensation temperature and the return temperature. The balance temperature is only active if a room temperature sensor is connected.

BMS

Building Management System. A supervisory system for remote control and monitoring.

Comfort operation

Normal temperature in the system controlled by the schedule. During heating the flow temperature in the system is higher to maintain the desired room temperature. During cooling the flow temperature in the system is lower to maintain the desired room temperature.

Comfort temperature

Temperature maintained in the circuits during comfort periods. Normally during daytime.

Compensation temperature

A measured temperature influencing the flow temperature reference / balance temperature.

Desired flow temperature

Temperature calculated by the controller on basis of the outdoor temperature and influences from the room and / or return temperatures. This temperature is used as a reference for the control.

Desired room temperature

Temperature which is set as the desired room temperature. The temperature can only be controlled by the ECL Comfort controller if a room temperature sensor is installed.

If a sensor is not installed, the set desired room temperature however still influences the flow temperature.

In both cases the room temperature in each room is typically controlled by radiator thermostats / valves.

Desired temperature

Temperature based on a setting or a controller calculation.

Dew point temperature

Temperature at which the humidity in the air condensates.

DHW circuit

The circuit for heating the domestic hot water (DHW).

Duct temperature

Temperature measured in the air duct where the temperature is to be controlled.

ECL 485 Bus

This communication bus is Danfoss proprietary and used for internal communication between ECL 210, ECL 210B, ECL 296, ECL 310, ECL 310B, ECA 30 and ECA 31.

Communication with "ECL Bus", used in ECL 100, ECL 110, ECL 200, ECL 300 and ECL 301, is not possible.

ECL Portal

A supervisory system for remote control and monitoring, locally and via Internet.

EMS

Energy Management System. A supervisory system for remote control and monitoring.

Factory settings

Settings stored on the ECL Application Key to simplify the set up of your controller the first time.

Firmware

is used by the ECL Comfort controller and ECA 30 / 31 to manage display, dial and program execution.

Flow temperature

Temperature measured in the water flow where the temperature is to be controlled.

Flow temperature reference

Temperature calculated by the controller on basis of the outdoor temperature and influences from the room and / or return temperatures. This temperature is used as a reference for the control.

Heat curve

A curve showing the relationship between actual outdoor temperature and desired flow temperature.

Heating circuit

The circuit for heating the room / building.

Holiday schedule

Selected days can be programmed to be in comfort, saving or frost protection mode. Besides this, a day schedule with comfort period from 07.00 to 23.00 can be selected.

Humidistat

A device, which reacts on the air's humidity. A switch can go ON if the measured humidity gets above a set point.

Humidity, relative

This value (stated in %) refers to the indoor moisture content compared to the max. moisture content. The relative humidity is measured by the ECA 31 and is used for the calculation of the dew point temperature.

Inlet temperature

Temperature measured in the inlet air flow where the temperature is to be controlled.

Limitation temperature

Temperature that influences the desired flow / balance temperature.

Log function

The temperature history is displayed.

Master / slave

Two or more controllers are interconnected on the same bus, the master sends out e.g. time, date and outdoor temperature. The slave receives data from master and sends e.g. desired flow temperature value.

Modulating control (0 - 10 V control)

Positioning (by means of a 0 - 10 V control signal) of the actuator for the motorized control valve in order to control the flow.

Optimization

The controller optimizes the start time of the scheduled temperature periods. Based on the outdoor temperature, the controller automatically calculates when to start in order to reach the comfort temperature at the set time. The lower the outdoor temperature, the earlier the start time.

Outdoor temperature trend

The arrow indicates the tendency, i.e. whether the temperature rises or falls.

Override mode

When ECL Comfort is in Scheduled mode, a switch or contact signal can be applied to an input in order to override to Comfort, Saving, Frost protection or Constant temperature. As long as the switch or contact signal is applied, the override is active.

Pt 1000 sensor

All sensors used with the ECL Comfort controller are based on the Pt 1000 type (IEC 751B). The resistance is 1000 ohm at 0 °C and it changes with 3.9 ohm / degree.

Pump control

One circulation pump is working and the other is the spare circulation pump. After a set time, the roles are exchanged.

Refill water function

If the measured pressure in the heating system is too low (e.g. due to a leakage), water can be supplemented.

Return temperature

The temperature measured in the return influences the desired flow temperature.

Room temperature

Temperature measured by the room temperature sensor or the Remote Control Unit. The room temperature can only be controlled directly if a sensor is installed. The room temperature influences the desired flow temperature.

Room temperature sensor

Temperature sensor placed in the room (reference room, typically the living room) where the temperature is to be controlled.

Saving temperature

Temperature maintained in the heating / DHW circuit during saving temperature periods. Typically, the Saving temperature is lower than the Comfort temperature in order to save energy.

SCADA

Supervisory Control And Data Acquisition. A supervisory system for remote control and monitoring.

Schedule

Schedule for periods with comfort and saving temperatures. The schedule can be made individually for each week day and may consist of up to 3 comfort periods per day.

Software

is used in the ECL Comfort controller to do the application related processes.

Weather compensation

Flow temperature control based on the outdoor temperature. The control is related to a user-defined heat curve.

2-point control

ON / OFF control, e.g. circulation pump, ON / OFF valve, change-over valve or damper control.

3-point control

Actuator positioning by means of Opening, Closing or No-action signals for the motorized control valve in order to control the flow. No-action means that the actuator remains in its current position.

Operating Guide ECL Comfort 210 / 296 / 310, application A266

7.6 Type (ID 6001), overview

	Type 0	Type 1	Type 2	Type 3	Type 4
Address	✓	✓	✓	✓	✓
Type	✓	✓	✓	✓	✓
Scan time	✓	✓	✓	✓	✓
ID / Serial	✓	✓	✓	✓	✓
Reserved	✓	✓	✓	✓	✓
Flow temp. [0.01 °C]	✓	✓	✓	✓	-
Return temp. [0.01 °C]	✓	✓	✓	✓	-
Flow [0.1 l/h]	✓	✓	✓	✓	-
Power [0.1 kW]	✓	✓	✓	✓	-
Acc. Volume	[0.1 m3]	[0.1 m3]	[0.1 m3]	[0.1 m3]	-
Acc. Energy	[0.1 kWh]	[0.1 MWh]	[0.1 kWh]	[0.1 MWh]	-
Tariff1 Acc. Energy	-	-	[0.1 kWh]	[0.1 MWh]	-
Tariff2 Acc. Energy	-	-	[0.1 kWh]	[0.1 MWh]	-
Up time [days]	-	-	✓	✓	-
Current time [M-bus defined structure]	-	-	✓	✓	✓
Error status [energy meter defined bitmask]	-	-	✓	✓	-
Acc. Volume	-	-	-	-	[0.1 m3]
Acc. Energy	-	-	-	-	[0.1 kWh]
Acc. Volume2	-	-	-	-	[0.1 m3]
Acc. Energy2	-	-	-	-	[0.1 kWh]
Acc. Volume3	-	-	-	-	[0.1 m3]
Acc. Energy3	-	-	-	-	[0.1 kWh]
Acc. Volume4	-	-	-	-	[0.1 m3]
Acc. Energy4	-	-	-	-	[0.1 kWh]
Flow MAX	[0.1 l/h]	[0.1 l/h]	[0.1 l/h]	[0.1 l/h]	-
Power MAX	[0.1 kW]	[0.1 kW]	[0.1 kW]	[0.1 kW]	-
Max T forward	✓	✓	✓	✓	-
Max T return	✓	✓	✓	✓	-
Storage * Acc. Energy	[0.1 kWh]	[0.1 kWh]	[0.1 kWh]	[0.1 kWh]	-

7.7 Automatic / manual update of firmware

Info:

- Firmware and application software are on the application key
- ECL Comfort has firmware implemented
- Firmware with Encryption has version 2.00 and up

Situation 1:

ECL Comfort controller, new (= no application installed), from before 10th of July 2018, to be installed:

1. Insert application key.
2. If the firmware on application key is newer than the firmware in the ECL, an update will be done automatically.
3. Hereafter the application can be uploaded.
4. If the firmware in the ECL is newer than the firmware on application key, the application can be uploaded.

Situation 2:

ECL Comfort controller is installed and runs an application.

1. Store all settings on the existing application key *.
2. Erase actual application in the ECL **.
3. Insert an application key with new firmware. The firmware update will be done automatically.
4. When ECL requires language selection, then remove application key.
5. Insert "old" application key.
6. Select language, select application subtype and see an "i" in upper right corner.
7. Set time / date if needed.
8. Choose "Next".
9. In Copy menu, choose YES at System and User settings; then choose "Next".
10. "Old" application is uploaded, ECL restarts and is ready again.

* Navigation: MENU > Common controller settings > Key functions > Copy > "To KEY", System settings = YES, User settings = YES, Start copying: Push dial.
Within 1 sec the settings are stored on the application key.

** Navigation: MENU > Common controller settings > Key functions > New application > Erase application: Push dial.

NOTE: You might come in a situation where the update will not elapse. This is typically when one or two ECA 30 are connected.

Remedy: Disconnect (remove from its base) the ECA 30. If ECL 310B, then only one ECA 30 should be connected.

Operating Guide ECL Comfort 210 / 296 / 310, application A266

7.8 Parameter ID overview

A266.x — x refers to the subtypes listed in the column.

ID	Parameter Name	A266.x	Setting range	Factory	Unit	Own settings	
10512	Prog. execution	1, 2, 9, 10	OFF ; ON	OFF			
10514	Max. pwr. failure	1, 2, 9, 10	5 ... 3000	30	Min		
10903	Ramp X5-X6	1, 2, 9, 10	OFF, 1 ... 20	5			
10904	Ramp X7-X8	1, 2, 9, 10	OFF, 1 ... 20	5			
10912	Appl. continue	1, 2, 9, 10	OFF ; ON	OFF			
10913	After power fail.	1, 2, 9, 10	STOP ; START	OFF			
10930	X1	1, 2, 9, 10	0 ... 1200	0	h		
10931	X2	1, 2, 9, 10	0 ... 1200	0	h		
10932	X3	1, 2, 9, 10	0 ... 1200	0	h		
10933	X4	1, 2, 9, 10	0 ... 1200	0	h		
10934	X5	1, 2, 9, 10	0 ... 1200	0	h		
10935	X6	1, 2, 9, 10	0 ... 1200	360	h		
10936	X7	1, 2, 9, 10	0 ... 1200	720	h		
10937	X8	1, 2, 9, 10	0 ... 1200	1080	h		
11004	Desired T	1, 2, 9, 10	5 ... 150	50	°C		73
11010	ECA addr.	1, 2	OFF ; A ; B	OFF			102
11011	Auto saving	1, 2, 9, 10	OFF, -29 ... 10	-15	°C		88
11012	Boost	1, 2, 9, 10	OFF, 1 ... 99	OFF	%		89
11013	Ramp	1, 2, 9, 10	OFF, 1 ... 99	OFF	Min		90
11014	Optimizer	1, 2, 9, 10	OFF, 10 ... 59	OFF			90
11015	Adapt. time	1, 2	OFF, 1 ... 50	OFF	Sec		75
	- -	9, 10	OFF, 1 ... 50	25	Sec		
11017	Demand offset	1, 2, 9, 10	OFF, 1 ... 20	OFF	K		102
11020	Based on	1, 2	OUT ; ROOM	OUT			91
11021	Total stop	1, 2, 9, 10	OFF ; ON	OFF			91
11022	P exercise	1, 2, 9, 10	OFF ; ON	ON			102
11023	M exercise	1, 2, 9, 10	OFF ; ON	OFF			103
11024	Actuator	1, 2, 9, 10	ABV ; GEAR	GEAR			96
11026	Pre-stop	1, 2, 9, 10	OFF ; ON	ON			92
11028	Con. T, ret. T lim.	1, 2, 9, 10	10 ... 110	70	°C		79
11029	DHW, ret. T limit	1, 2, 9, 10	OFF, 10 ... 110	OFF	°C		79
11031	High T out X1	1, 2, 9, 10	-60 ... 20	15	°C		80
11032	Low limit Y1	1, 2, 9, 10	10 ... 150	50	°C		80
11033	Low T out X2	1, 2, 9, 10	-60 ... 20	-15	°C		80
11034	High limit Y2	1, 2, 9, 10	10 ... 150	60	°C		81
11035	Infl. - max.	1, 2	-9.9 ... 9.9	-2.0			81
	- -	9, 10	-9.9 ... 9.9	0.0			
11036	Infl. - min.	1, 2, 9, 10	-9.9 ... 9.9	0.0			81

Operating Guide ECL Comfort 210 / 296 / 310, application A266

ID	Parameter Name	A266.x	Setting range	Factory	Unit	Own settings	
11037	Adapt. time	1, 2, 9, 10	OFF, 1 ... 50	25	Sec		81
11040	P post-run	1, 2, 9, 10	0 ... 99	3	Min		103
11043	Parallel operation	1, 2, 9, 10	OFF, 1 ... 99	OFF	K		92
11050	P demand	1, 2, 9, 10	OFF ; ON	OFF			103
11052	DHW priority	1, 2, 9, 10	OFF ; ON	OFF			104
11077	P frost T	1, 2, 9, 10	OFF, -10 ... 20	2	°C		104
11078	P heat T	1, 2, 9, 10	5 ... 40	20	°C		104
11079	Max. flow T	2	10 ... 110	100	°C		114
	- -	9, 10	10 ... 110	90	°C		
11080	Delay	2	5 ... 250	30	Sec		114
	- -	9, 10	5 ... 250	60	Sec		
11085	Priority	1, 2, 9, 10	OFF ; ON	OFF			82
11093	Frost pr. T	1, 2, 9, 10	5 ... 40	10	°C		105
11109	Input type	1, 2, 10	OFF ; IM1 ; IM2 ; IM3 ; IM4 ; EM1 ; EM2 ; EM3 ; EM4 ; EM5	OFF			84
	- -	9	EM1 ; EM2 ; EM3 ; EM4 ; EM5 ; OFF	OFF			
11112	Adapt. time	1, 2, 9, 10	OFF, 1 ... 50	OFF	Sec		84
11113	Filter constant	1, 2, 9, 10	1 ... 50	10			85
11114	Pulse	1, 2, 10	OFF, 1 ... 9999	OFF			85
11115	Units	1, 2, 9, 10	ml, l/h ; l, l/h ; ml, m3/h ; l, m3/h ; Wh, kW ; kWh, kW ; kWh, MW ; MWh, MW ; MWh, GW ; GWh, GW	ml, l/h			85
11116	High limit Y2	1, 2, 9, 10	0.0 ... 999.9	999.9			86
11117	Low limit Y1	1, 2, 9, 10	0.0 ... 999.9	999.9			86
11118	Low T out X2	1, 2, 9, 10	-60 ... 20	-15	°C		86
11119	High T out X1	1, 2, 9, 10	-60 ... 20	15	°C		87
11141	Ext. input	1, 2, 9, 10	OFF ; S1 ; S2 ; S3 ; S4 ; S5 ; S6 ; S7 ; S8 ; S9 ; S10 ; S11 ; S12 ; S13 ; S14 ; S15 ; S16	OFF			105
11142	Ext. mode	1, 2, 9, 10	COMFORT ; SAVING ; FROST PR. ; CONST. T	COMFORT			106
11147	Upper difference	1, 2	OFF, 1 ... 30	OFF	K		114
11148	Lower difference	1, 2	OFF, 1 ... 30	OFF	K		115
11149	Delay	1, 2	1 ... 99	10	Min		115
11150	Lowest temp.	1, 2	10 ... 50	30	°C		116
11174	Motor pr.	1, 2, 9, 10	OFF, 10 ... 59	OFF	Min		98
11177	Temp. min.	1, 2, 9, 10	10 ... 150	10	°C		74
11178	Temp. max.	1, 2, 9, 10	10 ... 150	90	°C		74
11179	Summer, cut-out	1, 2, 9, 10	OFF, 1 ... 50	20	°C		
11182	Infl. - max.	1, 2, 9, 10	-9.9 ... 0.0	-4.0			75

Operating Guide ECL Comfort 210 / 296 / 310, application A266

ID	Parameter Name	A266.x	Setting range	Factory	Unit	Own settings	
11183	Infl. - min.	1, 2, 9, 10	0.0 ... 9.9	0.0			76
11184	Xp	1, 2, 9, 10	5 ... 250	120	K		98
11185	Tn	1, 2, 9, 10	1 ... 999	50	Sec		99
11186	M run	1, 2, 9, 10	5 ... 250	60	Sec		99
11187	Nz	1, 2, 9, 10	1 ... 9	3	K		99
11189	Min. act. time	1, 2, 9, 10	2 ... 50	10			99
11392	Sum. start, month	1, 2, 9, 10	1 ... 12	5			111
11393	Sum. start, day	1, 2, 9, 10	1 ... 31	20			111
11395	Summer, filter	1, 2, 9, 10	OFF, 1 ... 300	250			111
11396	Win. start, month	1, 2, 9, 10	1 ... 12	5			111
11397	Winter start, day	1, 2, 9, 10	1 ... 31	20			111
11398	Winter, cut-out	1, 2, 9, 10	OFF, 1 ... 50	20	°C		111
11399	Winter, filter	1, 2, 9, 10	OFF, 1 ... 300	250			111
11500	Send desired T	1, 2, 9, 10	OFF ; ON	ON			108
11600	Pressure	9	-7.8125 ... 7.8125	0.0	Bar		
11607	Low X	9	0.0 ... 10.0	1.0			116
11608	High X	9	0.0 ... 10.0	5.0			116
11609	Low Y	9	0.0 ... 10.0	0.0			116
11610	High Y	9	0.0 ... 10.0	6.0			117
11614	Alarm high	9	0.0 ... 6.0	2.3			117
11615	Alarm low	9	0.0 ... 6.0	0.8			117
11617	Alarm time-out	9	0 ... 240	30	Sec		117
11623	Digital	9, 10	0 ... 1	0			
11636	Alarm value	9, 10	0 ... 1	1			117
11637	Alarm time-out	9, 10	0 ... 240	30	Sec		118
11910	Circuit, Estrich.	1, 2, 9, 10	OFF ; ON	ON			
12022	P exercise	1, 2	OFF ; ON	OFF			102
	- -	9, 10	OFF ; ON	ON			
12023	M exercise	1, 2, 9, 10	OFF ; ON	OFF			103
12024	Actuator	1, 2, 9, 10	ABV ; GEAR	GEAR			96
12030	Limit	1, 2, 9, 10	10 ... 120	60	°C		80
12035	Infl. - max.	1, 2	-9.9 ... 9.9	-2.0			81
	- -	9, 10	-9.9 ... 9.9	0.0			
12036	Infl. - min.	1, 2, 9, 10	-9.9 ... 9.9	0.0			81
12037	Adapt. time	1, 2, 9, 10	OFF, 1 ... 50	25	Sec		81
12040	P post-run	1, 2, 9, 10	0 ... 99	3	Min		103
12077	P frost T	1, 2, 9, 10	OFF, -10 ... 20	2	°C		104
12078	P heat T	1, 2, 9, 10	5 ... 80	20	°C		104
12085	Priority	1, 2	OFF ; ON	OFF			82
12093	Frost pr. T	1, 2, 9, 10	5 ... 40	10	°C		105
12094	Open time	2	OFF, 0.1 ... 25.0	4.0	Sec		96

Operating Guide ECL Comfort 210 / 296 / 310, application A266

ID	Parameter Name	A266.x	Setting range	Factory	Unit	Own settings	
12095	Close time	2	OFF, 0.1 ... 25.0	2.0	Sec		97
12096	Tn (idle)	2	1 ... 999	120	Sec		97
12097	Supply T (idle)	2	OFF ; ON	OFF			97
12109	Input type	1, 2, 10	OFF ; IM1 ; IM2 ; IM3 ; IM4 ; EM1 ; EM2 ; EM3 ; EM4 ; EM5	OFF			84
	- -	9	EM1 ; EM2 ; EM3 ; EM4 ; EM5 ; OFF	OFF			
12111	Limit	1, 2, 9, 10	0.0 ... 999.9	999.9			84
12112	Adapt. time	1, 2, 9, 10	OFF, 1 ... 50	OFF	Sec		84
12113	Filter constant	1, 2, 9, 10	1 ... 50	10			85
12114	Pulse	1, 2, 10	OFF, 1 ... 9999	OFF			85
12115	Units	1, 2, 9, 10	ml, l/h ; l, l/h ; ml, m3/h ; l, m3/h ; Wh, kW ; kWh, kW ; kWh, MW ; MWh, MW ; MWh, GW ; GWh, GW	ml, l/h			85
12122	Day:	1, 2, 9, 10	0 ... 127	0			
12123	Start time	1, 2, 9, 10	0 ... 47	0			
12124	Duration	1, 2, 9, 10	10 ... 600	120	Min		
12125	Desired T	1, 2, 9, 10	OFF, 10 ... 110	OFF	°C		
12141	Ext. input	1, 2, 9, 10	OFF ; S1 ; S2 ; S3 ; S4 ; S5 ; S6 ; S7 ; S8 ; S9 ; S10 ; S11 ; S12 ; S13 ; S14 ; S15 ; S16	OFF			105
12142	Ext. mode	1, 2, 9, 10	COMFORT ; SAVING ; FROST PR.	COMFORT			106
12147	Upper difference	1, 2	OFF, 1 ... 30	OFF	K		114
12148	Lower difference	1, 2	OFF, 1 ... 30	OFF	K		115
12149	Delay	1, 2	1 ... 99	10	Min		115
12150	Lowest temp.	1, 2	10 ... 50	30	°C		116
12173	Auto tuning	1, 2, 9, 10	OFF ; ON	OFF			97
12174	Motor pr.	1, 2, 9, 10	OFF, 10 ... 59	OFF	Min		98
12177	Temp. min.	1, 2	10 ... 150	10	°C		74
	- -	9, 10	10 ... 150	45	°C		
12178	Temp. max.	1, 2	10 ... 150	90	°C		74
	- -	9, 10	10 ... 150	65	°C		
12184	Xp	1, 2	5 ... 250	40	K		98
	- -	9, 10	5 ... 250	90	K		
12185	Tn	1, 2	1 ... 999	20	Sec		99
	- -	9, 10	1 ... 999	13	Sec		
12186	M run	1, 2	5 ... 250	20	Sec		99
	- -	9, 10	5 ... 250	15	Sec		
12187	Nz	1, 2, 9, 10	1 ... 9	3	K		99
12189	Min. act. time	1, 2	2 ... 50	3			99

Operating Guide ECL Comfort 210 / 296 / 310, application A266

ID	Parameter Name	A266.x	Setting range	Factory	Unit	Own settings	
	- -	9, 10	2 ... 50	10			
12500	Send desired T	1, 2, 9, 10	OFF ; ON	ON			108

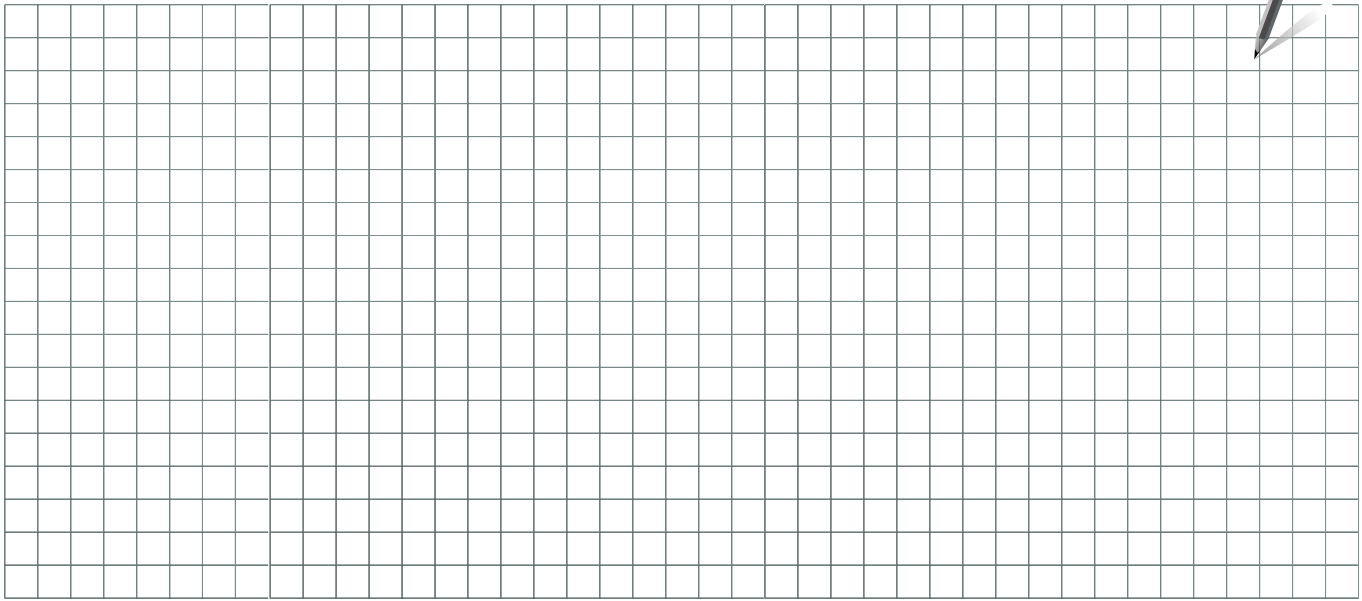

Installer:
By:
Date:

Operating Guide ECL Comfort 210 / 296 / 310, application A266



Danfoss A/S

Climate Solutions • danfoss.com • +45 7488 2222

Any information, including, but not limited to information on selection of product, its application or use, product design, weight, dimensions, capacity or any other technical data in product manuals, catalogues descriptions, advertisements, etc. and whether made available in writing, orally, electronically, online or via download, shall be considered informative, and is only binding if and to the extent, explicit reference is made in a quotation or order confirmation. Danfoss cannot accept any responsibility for possible errors in catalogues, brochures, videos and other material. Danfoss reserves the right to alter its products without notice. This also applies to products ordered but not delivered provided that such alterations can be made without changes to form, fit or function of the product.

All trademarks in this material are property of Danfoss A/S or Danfoss group companies. Danfoss and the Danfoss logo are trademarks of Danfoss A/S. All rights reserved.